

pH 7310

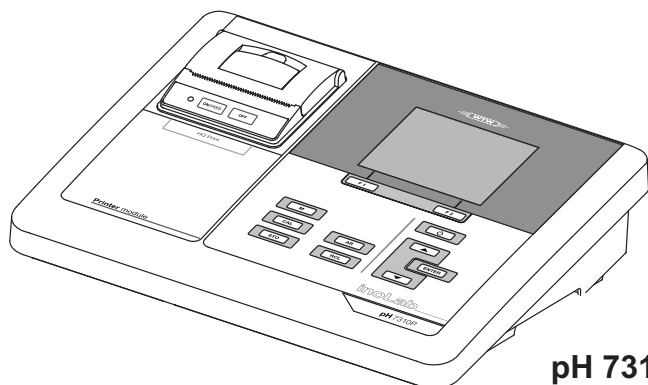

pH 7310P

pH 7310

pH 7310P

pH METER



a xylem brand

Copyright

© 2017 Xylem Analytics Germany GmbH
Printed in Germany.

pH 7310 - Contents

1	Overview	6
1.1	pH 7310 meter	6
1.2	pH 7310P meter with integrated printer	7
1.3	Sensors	7
2	Safety	8
2.1	Safety information	8
2.1.1	Safety information in the operating manual	8
2.1.2	Safety signs on the meter	8
2.1.3	Further documents providing safety information	8
2.2	Safe operation	9
2.2.1	Authorized use	9
2.2.2	Requirements for safe operation	9
2.2.3	Unauthorized use	9
3	Commissioning	10
3.1	Scope of delivery	10
3.2	Power supply	10
3.3	Initial commissioning	10
3.3.1	Inserting the batteries	11
3.3.2	Connecting the power pack	12
3.3.3	Mounting the stand	12
4	Operation	13
4.1	General operating principles	13
4.1.1	Keypad	13
4.1.2	Display	14
4.1.3	Status information (meter)	14
4.1.4	Socket field	15
4.2	Switching on the meter	15
4.3	Switching off	16
4.4	Navigation	16
4.4.1	Measured value display	16
4.4.2	Operating modes	16
4.4.3	Menus and dialogs	17
4.4.4	Elements in menus and dialogs	17
4.4.5	Example 1 on navigation: Setting the language	18
4.4.6	Example 2 on navigation: Setting the date and time	20

5	pH value	22
5.1	Measuring	22
5.1.1	Measuring the pH value	22
5.1.2	Measuring the temperature	24
5.2	Calibration	25
5.2.1	Why calibrate?	25
5.2.2	When do you have to calibrate?	25
5.2.3	Automatic calibration (AutoCal)	25
5.2.4	Manual calibration (ConCal)	28
5.2.5	Calibration points	31
5.2.6	Calibration data	32
5.2.7	Continuous measurement control (CMC function) ..	34
6	ORP voltage	35
6.1	Measuring	35
6.1.1	Measuring the ORP	35
6.1.2	Measuring the temperature	37
6.2	ORP calibration	37
7	Settings	38
7.1	Measurement settings	38
7.1.1	Changing the settings for pH measurements	38
7.1.2	Buffer sets for calibration	39
7.1.3	Calibration interval	42
7.2	Settings for ORP measurements	42
7.3	Sensor-independent settings	43
7.3.1	<i>System</i>	43
7.3.2	<i>Data storage</i>	44
7.4	Reset	44
7.4.1	Resetting the measurement settings	44
7.4.2	Resetting the system settings	45
8	Data storage	46
8.1	Manual storage	46
8.2	Automatic storage at intervals	47
8.3	Measurement data storage	49
8.3.1	Editing the measured value storage	49
8.3.2	Erasing the measurement data storage	51
8.3.3	Measurement dataset	51
8.3.4	Storage locations	51
9	Transmitting data (USB interface)	52
9.1	Options for data transmission	52
9.2	Connecting a PC	53
9.3	MultiLab Importer	53
10	Printer (only pH 7310P)	54
10.1	Commissioning / switching the printer on or off	54

10.2	Operation / printing	55
10.3	Printer settings	55
10.4	Maintenance	55
10.4.1	Changing the roll of paper (thermal paper)	55
10.5	What to do if... / printer	56
11	Maintenance, cleaning, disposal	57
11.1	Maintenance	57
11.1.1	General maintenance activities	57
11.1.2	Replacing the batteries	57
11.2	Cleaning	58
11.3	Packing	58
11.4	Disposal	58
12	What to do if...	59
12.1	pH/ORP	59
12.2	General information	61
13	Technical data	62
13.1	Measuring ranges, resolution, accuracy	62
13.2	General data	63
14	Firmware update	65
15	Glossary	67
16	Index	69

1 Overview

1.1 pH 7310 meter

The compact pH 7310 precision pH meter enables you to perform pH measurements rapidly and reliably.

The pH 7310 provides the maximum degree of operating comfort, reliability and measuring certainty for all applications.

The USB interface can be used for data transmission to a PC and for software updates of the meter.

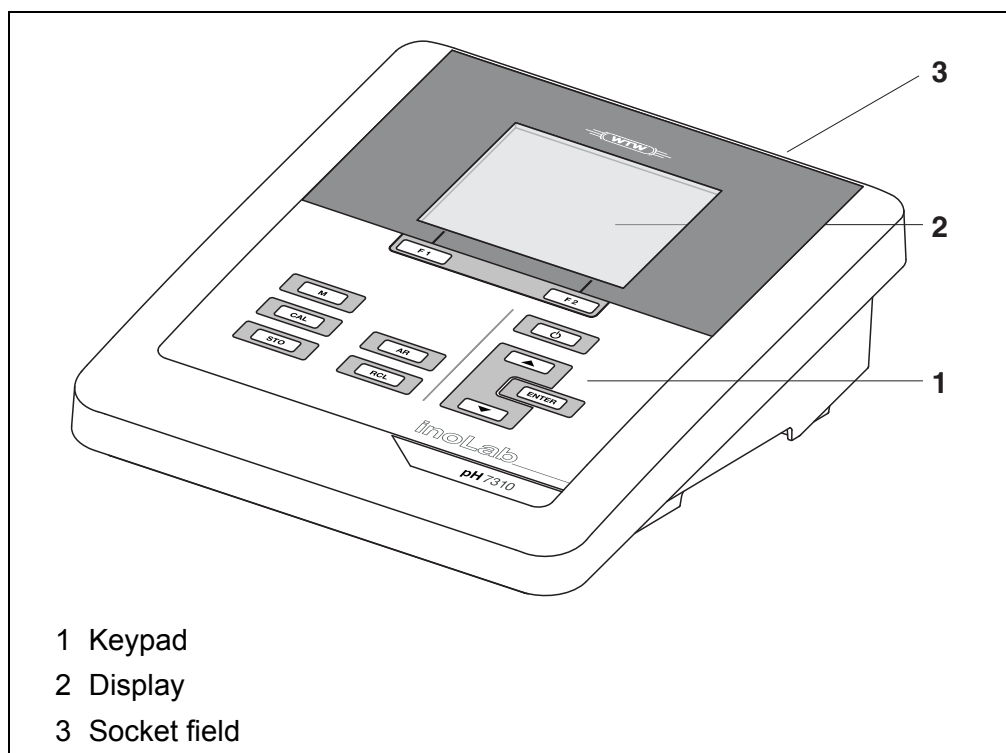

1.2 pH 7310P meter with integrated printer

The integrated printer of the pH 7310P enables to document measurements according to GLP requirements.



The information concerning the printer of the pH 7310P is given in a separate chapter (see section 10 PRINTER (ONLY PH 7310P), page 54).

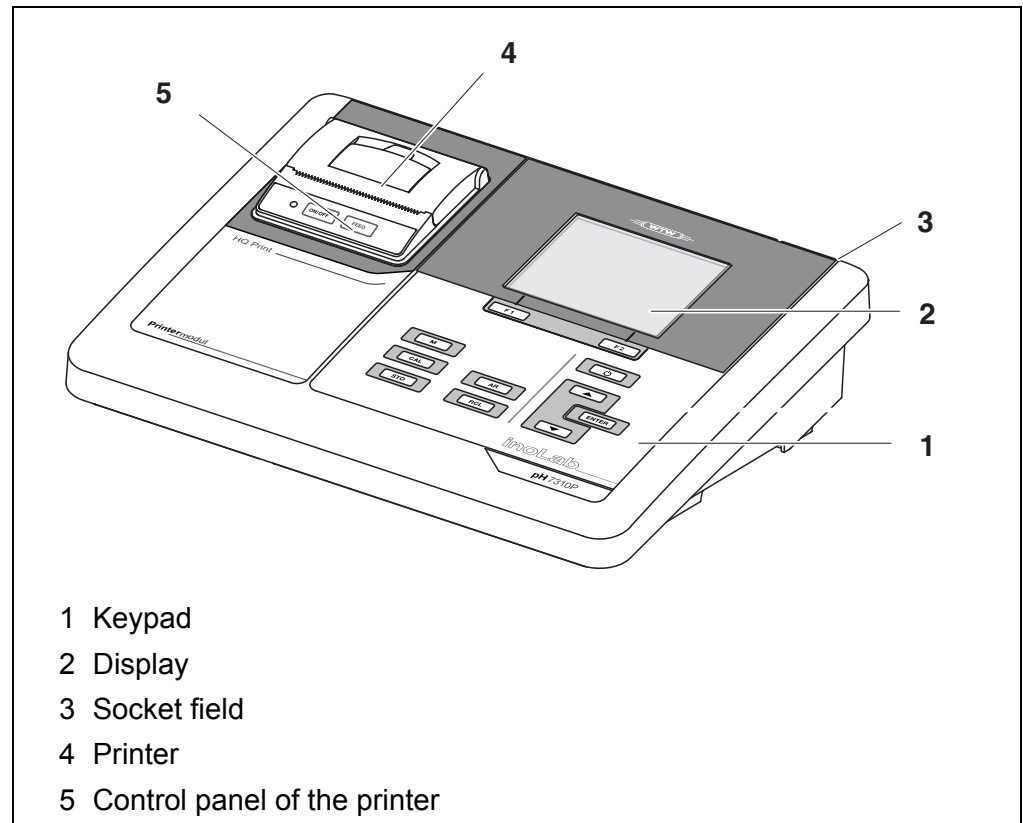

1.3 Sensors

A measuring system ready to measure consists of the pH 7310 meter and a suitable sensor.

Suitable sensors are pH electrodes and ORP electrodes.



Information on available sensors is given on the Internet and in the WTW catalog, "Laboratory and field instrumentation".

2 Safety

2.1 Safety information

2.1.1 Safety information in the operating manual

This operating manual provides important information on the safe operation of the meter. Read this operating manual thoroughly and make yourself familiar with the meter before putting it into operation or working with it. The operating manual must be kept in the vicinity of the meter so you can always find the information you need.

Important safety instructions are highlighted in this operating manual. They are indicated by the warning symbol (triangle) in the left column. The signal word (e.g. "CAUTION") indicates the level of danger:

**WARNING**

indicates a possibly dangerous situation that can lead to serious (irreversible) injury or death if the safety instruction is not followed.

**CAUTION**

indicates a possibly dangerous situation that can lead to slight (reversible) injury if the safety instruction is not followed.

NOTE

indicates a possibly dangerous situation where goods might be damaged if the actions mentioned are not taken.

2.1.2 Safety signs on the meter

Note all labels, information signs and safety symbols on the meter and in the battery compartment. A warning symbol (triangle) without text refers to safety information in this operating manual.

2.1.3 Further documents providing safety information

The following documents provide additional information, which you should observe for your safety when working with the measuring system:

- Operating manuals of sensors and other accessories
- Safety datasheets of calibration or maintenance accessories (such as buffer solutions, electrolyte solutions, etc.)

2.2 Safe operation

2.2.1 Authorized use

This meter is authorized exclusively for pH and ORP measurements in the laboratory.

Only the operation and running of the meter according to the instructions and technical specifications given in this operating manual is authorized (see section 13 TECHNICAL DATA, page 62).

Any other use is considered unauthorized.

2.2.2 Requirements for safe operation

Note the following points for safe operation:

- The meter may only be operated according to the authorized use specified above.
- The meter may only be supplied with power by the energy sources mentioned in this operating manual.
- The meter may only be operated under the environmental conditions mentioned in this operating manual.
- The meter may only be opened if this is explicitly described in this operating manual (example: Inserting the batteries).

2.2.3 Unauthorized use

The meter must not be put into operation if:

- it is visibly damaged (e.g. after being transported)
- it was stored under adverse conditions for a lengthy period of time (storing conditions, see section 13 TECHNICAL DATA, page 62).

3 Commissioning

3.1 Scope of delivery

- pH meter pH 7310
- 4 batteries 1.5 V Mignon type AA
- Power pack
- USB cable
- Stand
- Stand holder
- Comprehensive operating manual
- Short instructions
- CD-ROM with
 - USB drivers
 - comprehensive operating manual
 - software MultiLab Importer

3.2 Power supply

The pH 7310 is supplied with power in the following ways:

- Mains operation with the supplied power pack
- Battery operation (4 x alkaline manganese batteries, type AA)
- USB operation via a connected USB-B cable

3.3 Initial commissioning

Perform the following activities:

- Insert the supplied batteries
- For mains operation: Connect the power pack
- If necessary, mount a stand
- Switch on the meter (see section 4.2 SWITCHING ON THE METER, page 15)
- Set the date and time (see section 4.4.6 EXAMPLE 2 ON NAVIGATION: SETTING THE DATE AND TIME, page 20)

3.3.1 Inserting the batteries



You can operate the meter either with normal batteries or with rechargeable batteries (Ni-MH). In order to charge the batteries, an external charging device is required.

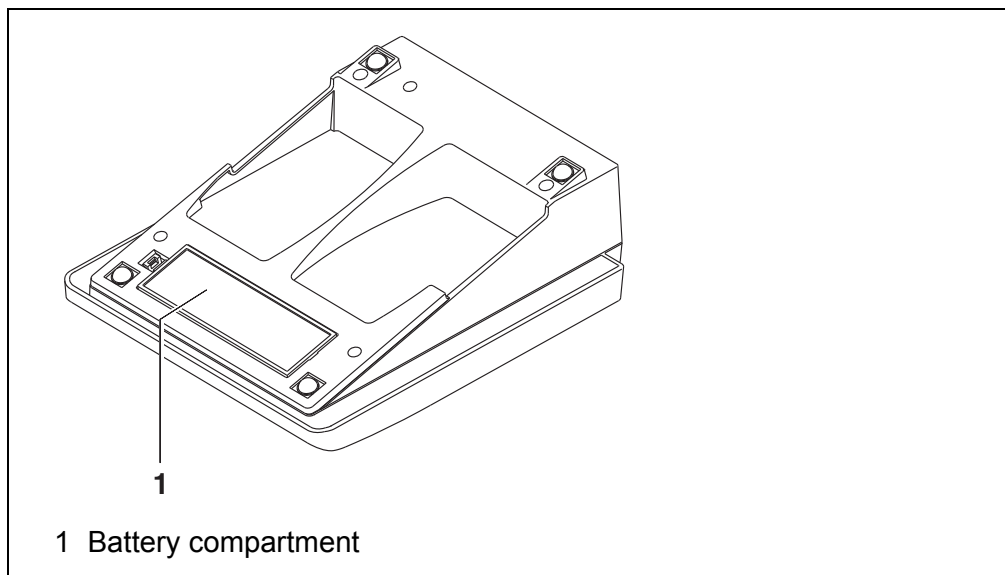

1. Open the battery compartment (1) on the underside of the meter.



CAUTION

Make sure that the poles of the batteries are positioned correctly.

The \pm -signs on the batteries must correspond to the \pm signs in the battery compartment.

2. Place four batteries (type Mignon AA) in the battery compartment.
3. Close the battery compartment (1).
4. Set the date and time
(see section 4.4.6 EXAMPLE 2 ON NAVIGATION: SETTING THE DATE AND TIME, page 20).

3.3.2 Connecting the power pack

**CAUTION**

The line voltage at the operating site must lie within the input voltage range of the original power pack (see section 13 TECHNICAL DATA, page 62).

**CAUTION**

Use original power packs only (see section 13 TECHNICAL DATA, page 62).

1. Connect the plug of the power pack to the socket for the power pack on the pH 7310.
2. Connect the original power pack to an easily accessible power outlet.

3.3.3 Mounting the stand

The stand base can be mounted at the right side of the meter.

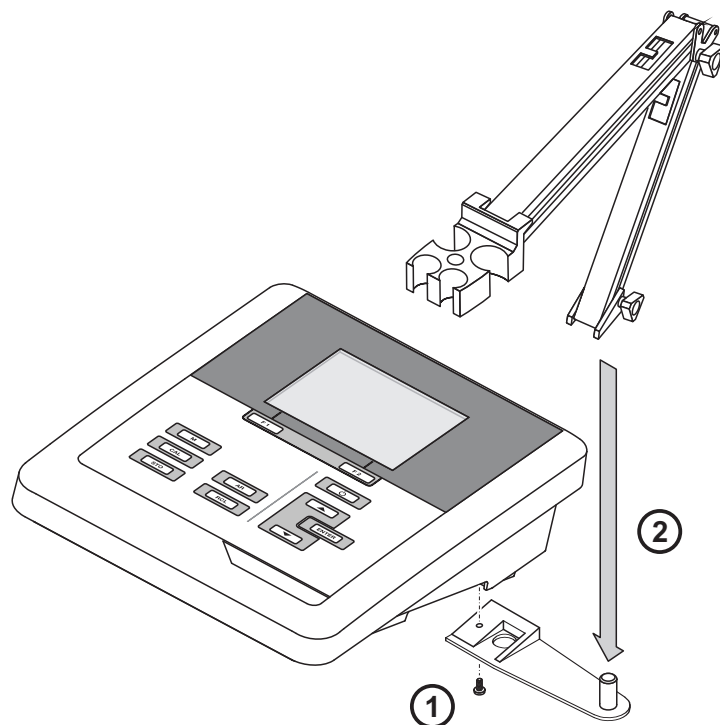









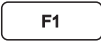
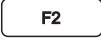

4 Operation

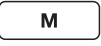
4.1 General operating principles

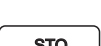
4.1.1 Keypad

In this operating manual, keys are indicated by brackets <.> .

The key symbol (e.g. <ENTER>) generally indicates a short keystroke (under 2 sec) in this operating manual. A long keystroke (approx. 2 sec) is indicated by the underscore behind the key symbol (e.g. <ENTER__>).

	<F1>: <F1__>:	Softkeys providing situation dependent functions, e.g.: <F1>/[Menu]: Opens the menu for measurement settings <F1__>/[Menu]: Opens the menu for system settings
	<F2>: <F2__>:	
	<On/Off>:	Switches the meter on or off
	<M>:	Selects the measured parameter / Quits the settings
	<CAL>: <CAL__>:	Calls up the calibration procedure Displays the calibration data
	<STO>: <STO__>:	Saves a measured value manually Opens the menu for the automatic save function
	<RCL>: <RCL__>:	Displays the manually stored measured values Displays the automatically stored measured values
	<▲><▼>: <▲__><▼__>:	Menu control, navigation Increments, decrements values Increments, decrements values continuously
		
	<ENTER>: <ENTER__>:	Opens the menu for measurement settings / confirms entries Opens the menu for system settings
	<AR>	Freezes the measured value (HOLD function) Switches the AutoRead measurement on or off

4.1.2 Display

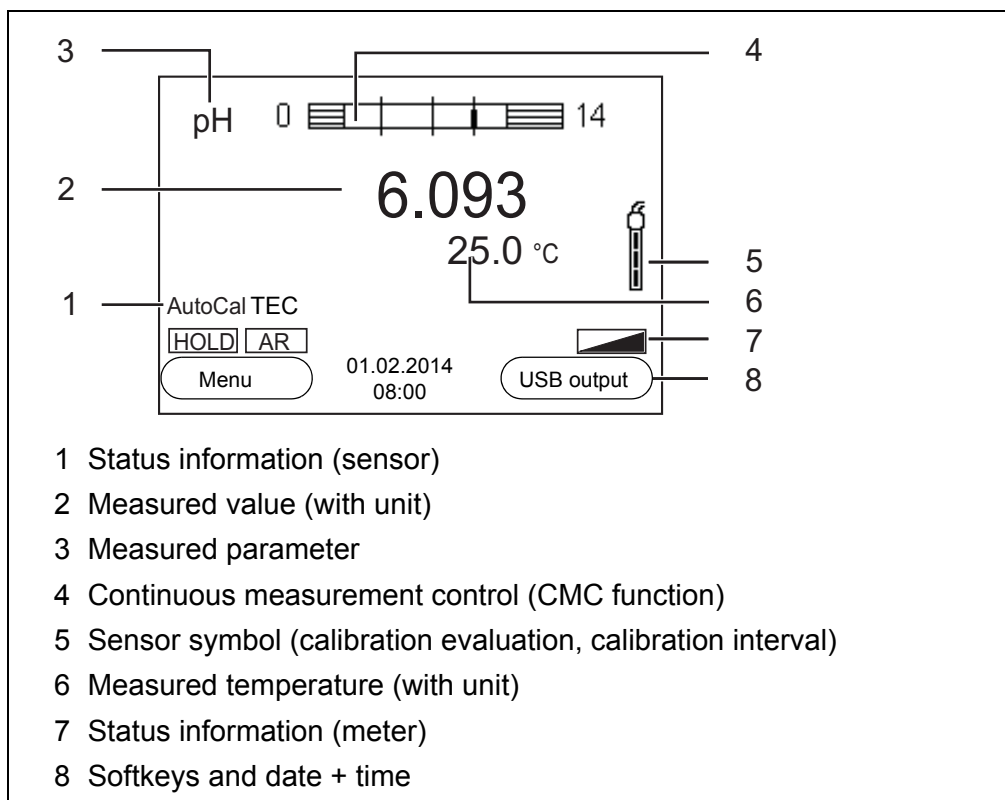

4.1.3 Status information (meter)

AR	Stability control (AutoRead) is active
HOLD	Measured value is frozen (<AR> key)
	Batteries are almost empty

4.1.4 Socket field

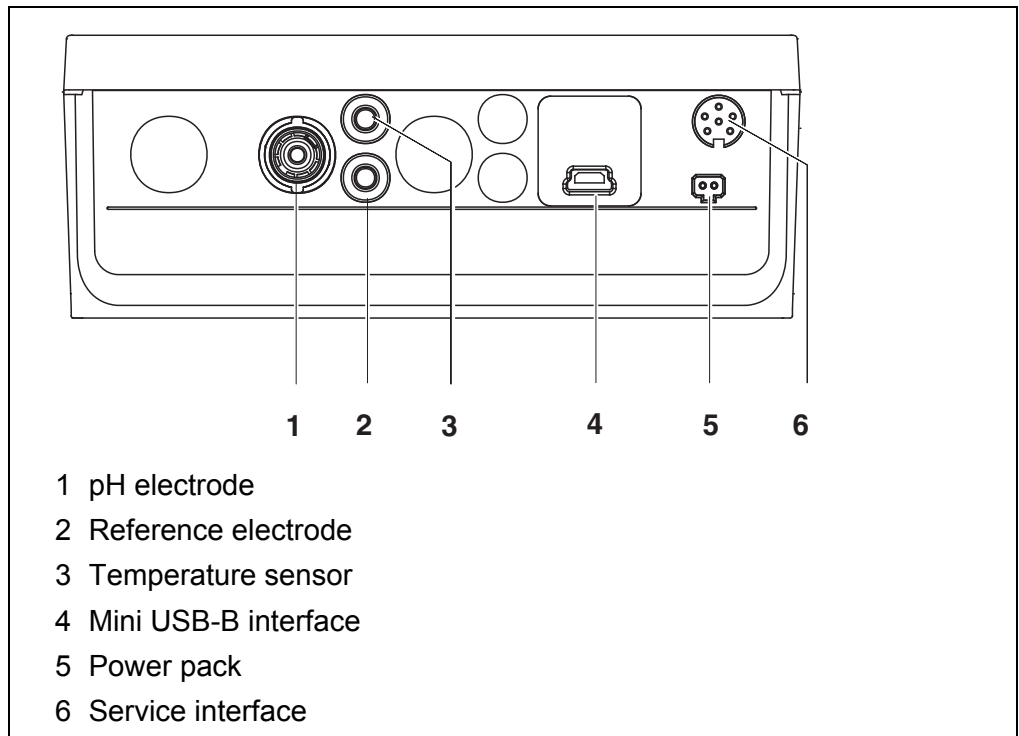

CAUTION

Only connect sensors to the meter that cannot return any voltages or currents that are not allowed ($> \text{SELV}$ and $> \text{current circuit with current limiting}$).

Almost all customary sensors meet these requirements.

4.2 Switching on the meter

1. Press the **<On/Off>** key.
The meter performs a self-test.
The display shows the manufacturer's logo while the self-test is being performed.
The measured value display appears.

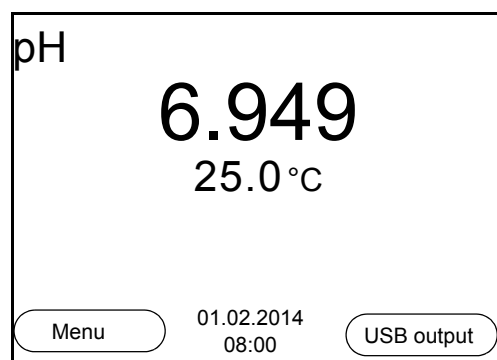

4.3 Switching off

1. Press the **<On/Off>** key.

Automatic switch-off function

The instrument has an automatic switch-off function in order to save the batteries (see section 7.3.1 SYSTEM, page 43). The automatic switchoff switches off the measuring instrument if no key is pressed for an adjustable period.

The automatic switchoff is not active

- if the communication cable is connected
- if the *Automatic data storage* function is active, or with *automatic data transmission*
- if the power pack is connected

Display illumination

The meter automatically switches off the display illumination if no key is pressed for 30 seconds. The illumination is switched on with the next keystroke again.

You can also generally switch the display illumination on or off (see section 7.3.1 SYSTEM, page 43).

4.4 Navigation

The principles of navigation in menus and dialogs are explained in the following sections.

4.4.1 Measured value display

In the measured value display, open the setting menus with the **<F1>** softkey. The current functions of the softkeys are shown on the display.

- Use **<F1>/[Menu]** (short pressure) to open the menu for calibration and measurement settings for the displayed measured parameter.
- Use **<F1__>/[Menu]** (long pressure (approx. 2 s) to open the *Storage & config* menu with the sensor-independent settings.

Use the keys of the keypad to carry out further functions such as storage or calibration (see section 4.1.1 KEYPAD, page 13). These functions are not available in other operating situations.

4.4.2 Operating modes

The meter has the following operating modes:

Operating mode	Description
Measuring	The measurement data of the connected sensor are shown in the measured value display
Calibration	The course of a calibration with calibration information, functions and settings is displayed
Storage in memory	The meter stores measuring data automatically or manually
Transmitting data	The meter transmits measurement data and calibration records to the USB interface automatically or manually.
Setting	The system menu or a sensor menu with submenus, settings and functions is displayed

4.4.3 Menus and dialogs

The menus for settings and dialogs in procedures contain further subelements.

- To select a subelement, use the <▲><▼> keys. The current selection is displayed with a frame.
- To make further settings, switch to the next higher menu level with <F1>[Back].
- Use <M> to return to the measured value display.

4.4.4 Elements in menus and dialogs

- Submenus

The name of the submenu is displayed at the upper edge of the frame. Submenus are opened by confirming with <ENTER>. Example:

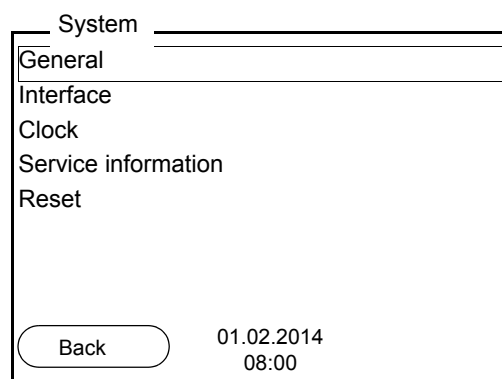

- Settings

Settings are indicated by a colon. The current setting is displayed on the right-hand side. The setting mode is opened with <ENTER>. Subsequently, the setting can be changed with <▲><▼> and <ENTER>. Example:

General	
Language:	English
Beep:	Off
Illumination:	On
Contrast:	50 %
Switchoff time:	1 h
<input type="button" value="Back"/> 01.02.2014 08:00	

- **Functions**

Functions are designated by the name of the function. They are immediately carried out by confirming with **<ENTER>**.

Example: Display the *Calibration record* function.

pH	
Calibration record	
Calibration data storage	
Buffer:	TEC
One point calibration:	Yes
Calibration interval:	7 d
Unit for slope:	mV/pH
[i] 2.00 4.01 7.00 10.01 (25 °C)	
<input type="button" value="Back"/> 01.02.2014 08:00	

- **Messages**

Information is marked by the **i** symbol. It cannot be selected. Example:

pH	
Calibration record	
Calibration storage	
Buffer:	<input type="text" value="TEC"/>
One point calibration:	Yes
Calibration interval:	7 d
Unit for slope:	mV/pH
[i] 2.00 4.01 7.00 10.01 (25 °C)	
<input type="button" value="Back"/> 01.02.2014 08:00	

4.4.5 Example 1 on navigation: Setting the language

1. Press the **<On/Off>** key.
The measured value display appears.
The instrument is in the measuring mode.

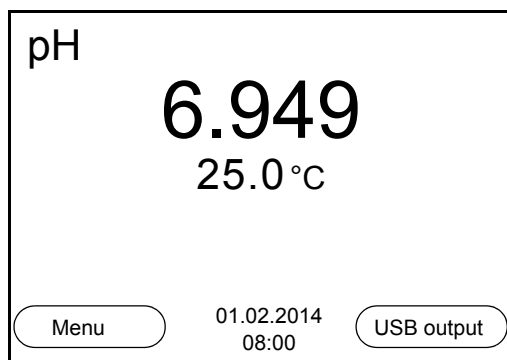

- Using **<F1__>/[Menu]**, open the *Storage & config* menu. The instrument is in the setting mode.

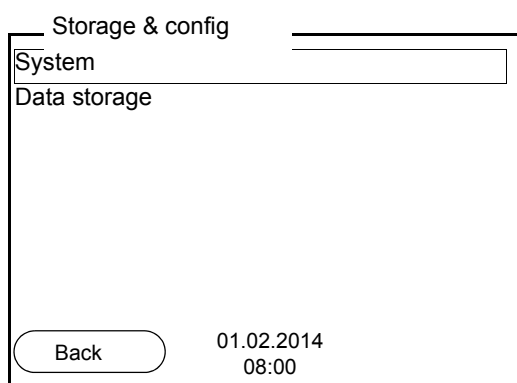

- Select the *System* submenu with **<▲><▼>**. The current selection is displayed with a frame.
- Open the *System* submenu with **<ENTER>**.

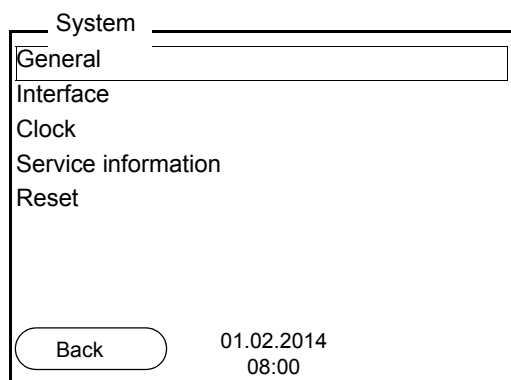

- Select the *General* submenu with **<▲><▼>**. The current selection is displayed with a frame.
- Open the *General* submenu with **<ENTER>**.

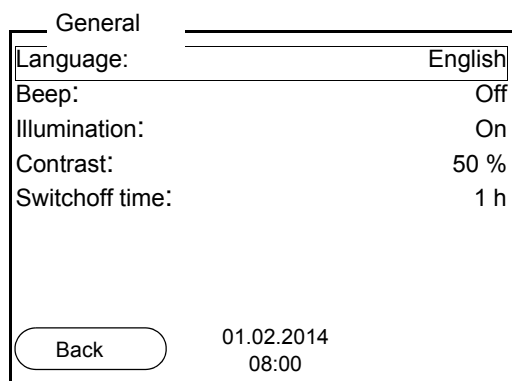

7. Open the setting mode for the *Language* with **<ENTER>**.

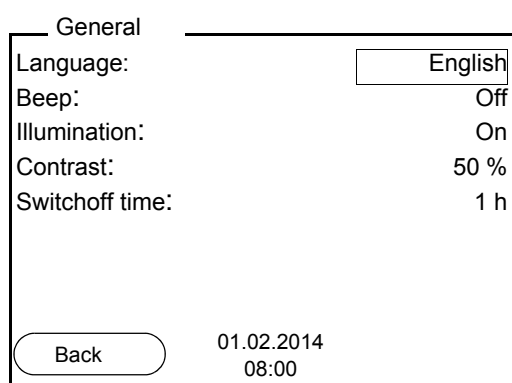

8. Select the required language with **<▲><▼>**.
9. Confirm the setting with **<ENTER>**.
The meter switches to the measuring mode.
The selected language is active.

4.4.6 Example 2 on navigation: Setting the date and time

The measuring instrument has a clock with a date function. The date and time are shown in the measured value display.

When storing measured values and calibrating, the current date and time are automatically stored as well.

The correct setting of the date and time and date format is important for the following functions and displays:

- Current date and time
- Calibration date
- Identification of stored measured values.

Therefore, check the time at regular intervals.



After a fall of the supply voltage (empty batteries), the date and time are reset.

The date format can be switched from the display of day, month, year (*dd.mm.yyyy*) to the display of month, day, year (*mm/dd/yyyy* or *mm.dd.yyyy*).

1. In the measured value display:
Using **<F1__>/[Menu]**, open the *Storage & config* menu.
The instrument is in the setting mode.
2. Select and confirm the *System / Clock* menu with **<▲><▼>** and **<ENTER>**.
The setting menu for the date and time opens up.
3. Select and confirm the *Time* menu with **<▲><▼>** and **<ENTER>**.
The hours are highlighted.

Clock	
Date format:	dd.mm.yyyy
Date:	01.02.2014
Time:	08:00:25
<div style="display: flex; justify-content: space-between; align-items: center;"> Back 01.02.2014 08:00 </div>	

4. Change and confirm the setting with **<▲><▼>** and **<ENTER>**.
The minutes are highlighted.
5. Change and confirm the setting with **<▲><▼>** and **<ENTER>**.
The seconds are highlighted.
6. Change and confirm the setting with **<▲><▼>** and **<ENTER>**.
The time is set.
7. If necessary, set the *Date* and *Date format*. The setting is made similarly to that of the time.
8. To make further settings, switch to the next higher menu level with **[Back]<F1>**.
or
Switch to the measured value display with **<M>**.
The instrument is in the measuring mode.

5 pH value

5.1 Measuring

5.1.1 Measuring the pH value

When connecting an earthed PC, measurements cannot be performed in earthed media as the values would be incorrect. The USB interface is not galvanically isolated.



To ensure the high measurement accuracy of the measuring system, always measure with a calibrated electrode (see section 5.2 CALIBRATION, page 25).

1. Connect the pH electrode to the meter.
2. If necessary, select the measured parameter with <M>.
3. When measuring without temperature sensor:
Temper the test sample or measure the current temperature and enter it with <▲> <▼>.
4. Immerse the pH electrode in the test sample.
The measured value is checked for stability (automatic stability control).
The display of the measured parameter flashes.
5. Wait for a stable measured value.
The display of the measured parameter no longer flashes.

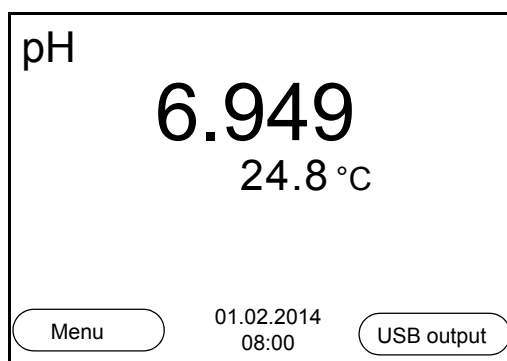

Stability control (AutoRead) & HOLD function

The stability control function (*AutoRead*) continually checks the stability of the measurement signal. The stability has a considerable impact on the reproducibility of measured values.

The measured parameter flashes on the display

- as soon as the measured value is outside the stability range
- when the automatic *Stability control* is switched off.

You can activate or switch off the automatic *Stability control* function (see section 7.1.1 CHANGING THE SETTINGS FOR PH MEASUREMENTS, page 38).

1. Freeze the measured value with **<AR>**.
The [HOLD] status indicator is displayed.
The HOLD function is active.



You can terminate the *Stability control* function and the HOLD function with **<AR>** or **<M>** at any time.

2. Using **<ENTER>**, activate the *Stability control* function manually.
The [AR] status indicator appears while the measured value is assessed as not stable. A progress bar is displayed and the display of the measured parameter flashes.
The [HOLD][AR] status indicator appears as soon as a stable measured value is recognized. The progress bar disappears and the display of the measured parameter stops flashing.
The current measurement data is output to the interface. Measurement data meeting the stability control criterion is marked by AR.



You can prematurely terminate the *Stability control* function manually with **<ENTER>** at any time. If the *Stability control* function is prematurely terminated, the current measurement data are output to the interface without the AutoRead info.

3. Using **<ENTER>**, start a further measurement with stability control.
or
Release the frozen measured value again with **<AR>** or **<M>**.
The [AR] status display disappears. The display switches back to the previous indication.

Criteria for a stable measured value

The *Stability control* function checks whether the measured values are stable within the monitored time interval.

Measured parameter	Time interval	Stability in the time interval
pH value	15 seconds	Δ : Better than 0.01 pH
Temperature	15 seconds	Δ : Better than 0.5 °C

The minimum duration until a measured value is assessed as stable is the monitored time interval. The actual duration is mostly longer.

5.1.2 Measuring the temperature

For reproducible pH and ORP measurements, it is essential to measure the temperature of the test sample.

You have the following options to measure the temperature:

- Automatic measurement of the temperature with the temperature sensor (NTC30 or Pt1000) integrated in the sensor.
- Measurement with an external temperature sensor.
- Manual determination and input of the temperature.

The measuring instrument recognizes whether a suitable sensor is connected and automatically switches on the temperature measurement.

The display of the temperature indicates the active temperature measuring mode:

Temperature sensor	Resolution of the temp. display	Temp. measurement
yes	0.1 °C	Automatic with temperature sensor
-	1 °C	Manual

If you wish to measure (or calibrate) without temperature sensor, proceed as follows:

1. Measure the current temperature of the test sample.
2. Set the temperature value with <▲><▼>.
 - or
 - In the <F1>/[Menu]/*Man. temperature* menu, set the temperature value with <▲><▼>.

5.2 Calibration

5.2.1 Why calibrate?

pH electrodes age. This changes the zero point (asymmetry) and slope of the pH electrode. As a result, an inexact measured value is displayed. Calibration determines and stores the current values of the zero point and slope of the electrode.

Thus, you should calibrate at regular intervals.

5.2.2 When do you have to calibrate?

- After connecting a sensor
- Routinely within the framework of the company quality assurance
- When the calibration interval has expired

5.2.3 Automatic calibration (AutoCal)

Make sure that in the sensor menu, *Buffer* menu, the buffer set is correctly selected (see 7.1.1 CHANGING THE SETTINGS FOR PH MEASUREMENTS, PAGE 38; 7.1.2 BUFFER SETS FOR CALIBRATION, PAGE 39).

Use any one to five buffer solutions of the selected buffer set in ascending or descending order.

Below, calibration with Technical buffers (*TEC*) is described. When other buffer sets are used, other nominal buffer values are displayed. Apart from that, the procedure is identical.



If single-point calibration was set in the menu, the calibration procedure is automatically finished with the measurement of buffer solution 1 and the calibration record is displayed.

1. Connect the pH electrode to the meter.
2. Keep the buffer solutions ready.
When measuring without temperature sensor:
Temper the buffer solutions or measure the current temperature.
3. In the measured value display, select the measured parameter pH or mV with **<M>**.
4. Start the calibration with **<CAL>**.
The calibration display for the first buffer appears (voltage display).

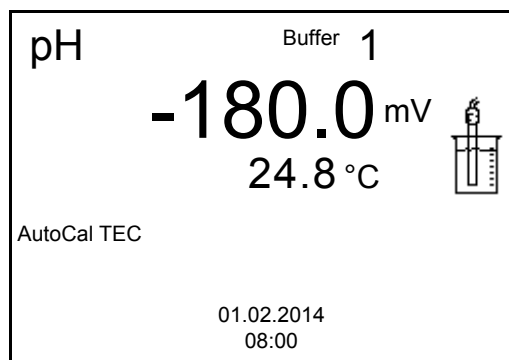

5. Thoroughly rinse the electrode with deionized water.
6. Immerse the electrode in the first buffer solution.
7. When measuring without temperature sensor:
Measure the temperature of the buffer and enter it with <▲><▼>.
8. Start the measurement with <ENTER>.
The measured value is checked for stability (stability control). The [AR] status indicator is displayed. A progress bar is displayed and the display of the measured parameter flashes.

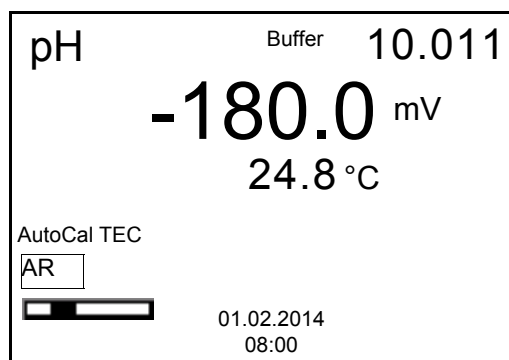

9. Wait for the end of the measurement with stability control or accept the calibration value with <ENTER>.
The calibration display for the next buffer appears (voltage display).
10. If necessary, finish the calibration procedure as a single-point calibration with <M>.
The calibration record is displayed.



For **single-point calibration**, the instrument uses the Nernst slope (-59.2 mV/pH at 25 °C) and determines the zero point of the electrode.

Continuing with two-point calibration

11. Thoroughly rinse the electrode with deionized water.
12. Immerse the electrode in the second buffer solution.
13. When measuring without temperature sensor:
Measure the temperature of the buffer and enter it with <▲><▼>.

14. Start the measurement with **<ENTER>**.
The measured value is checked for stability (stability control). The [AR] status indicator is displayed. A progress bar is displayed and the display of the measured parameter flashes.

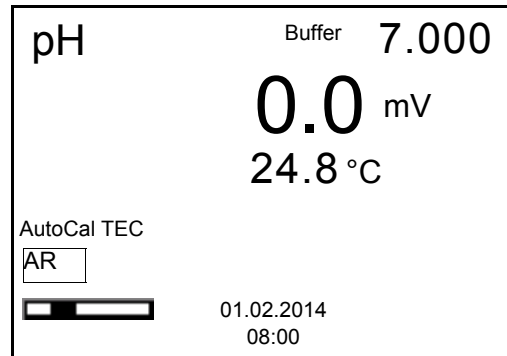

15. Wait for the measurement with stability control to be completed or terminate the stability control and take over the calibration value with **<ENTER>**.
The calibration display for the next buffer appears (voltage display).
16. If necessary, finish the calibration procedure as a two-point calibration with **<M>**.
The calibration record is displayed.

Continuing with three- to five-point calibration

17. Thoroughly rinse the electrode with deionized water.
18. Immerse the electrode in the next buffer solution.
19. When measuring without temperature sensor:
Measure the temperature of the buffer and enter it with **<▲><▼>**.
20. Start the measurement with **<ENTER>**.
The measured value is checked for stability (stability control). The [AR] status indicator is displayed. A progress bar is displayed and the display of the measured parameter flashes.

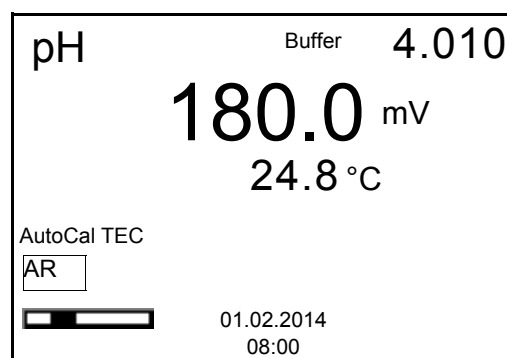

21. Wait for the measurement with stability control to be completed or terminate the stability control and take over the calibration value with **<ENTER>**.
The calibration display for the next buffer appears (voltage display).
22. If necessary, use **<M>** to finish calibration or continue calibrating using the next buffer with **<ENTER>**.



Calibration is automatically completed after the last buffer of a buffer set has been measured. Then the calibration record is displayed.

The calibration line is determined by linear regression.

5.2.4 Manual calibration (ConCal)

Make sure that in the sensor menu, *Buffer* menu, the *ConCal* buffer set is selected (see section 7.1.1 CHANGING THE SETTINGS FOR pH MEASUREMENTS, page 38).

Use any one to five buffer solutions in ascending or descending order.



If single-point calibration was set in the menu, the calibration procedure is automatically finished with the measurement of buffer solution 1 and the calibration record is displayed.

1. Connect the pH electrode to the meter.
The pH measuring window is displayed.
2. Keep the buffer solutions ready.
When measuring without temperature sensor:
Temper the buffer solutions or measure the current temperature.
3. In the measured value display, select the measured parameter pH or mV with **<M>**.
4. Start the calibration with **<CAL>**.
The calibration display appears.

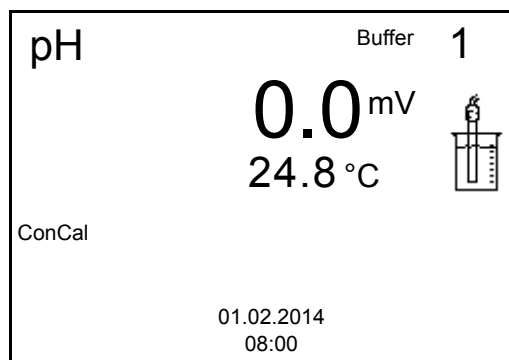

5. Thoroughly rinse the electrode with deionized water.

6. Immerse the electrode in the first buffer solution.
7. When measuring without temperature sensor:
Measure the temperature of the buffer and enter it with <▲><▼>.
8. Start the measurement with <ENTER>.
The measured value is checked for stability (stability control). The [AR] status indicator is displayed. A progress bar is displayed and the display of the measured parameter flashes.

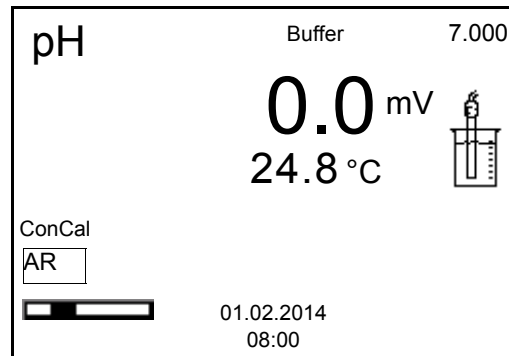

9. Wait for the end of the measurement with stability control or accept the calibration value with <ENTER>.
The calibration display for the setting of the nominal buffer value appears.

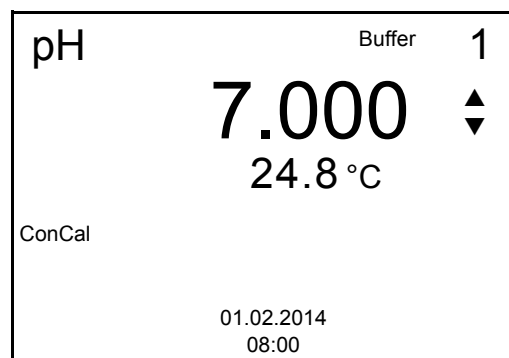

10. Set the nominal buffer value for the measured temperature with <▲><▼>.
11. Accept the set calibration value with <ENTER>.
The calibration display for the next buffer appears (voltage display).
12. If necessary, finish the calibration procedure as a single-point calibration with <M>.
The calibration record is displayed.



For **single-point calibration**, the instrument uses the Nernst slope (-59.2 mV/pH at 25 °C) and determines the zero point of the electrode.

Continuing with two-point calibration

13. Thoroughly rinse the electrode with deionized water.

14. Immerse the electrode in the second buffer solution.
15. When measuring without temperature sensor:
Measure the temperature of the buffer and enter it with **<▲><▼>**.
16. Start the measurement with **<ENTER>**.
The measured value is checked for stability (stability control). The [AR] status indicator is displayed. A progress bar is displayed and the display of the measured parameter flashes.
17. Wait for the measurement with stability control to be completed or terminate the stability control and take over the calibration value with **<ENTER>**.
The calibration display for the setting of the nominal buffer value appears.

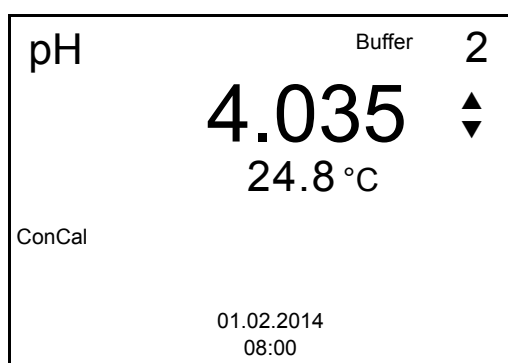

18. Set the nominal buffer value for the measured temperature with **<▲><▼>**.
19. Accept the set calibration value with **<ENTER>**.
The calibration display for the next buffer appears (voltage display).
20. Finish the calibration procedure as a two-point calibration with **<M>**.
The calibration record is displayed.

Continuing with three- to five-point calibration

21. Thoroughly rinse the electrode with deionized water.
22. Immerse the electrode in the next buffer solution.
23. When measuring without temperature sensor:
Measure the temperature of the buffer and enter it with **<▲><▼>**.
24. Start the measurement with **<ENTER>**.
The measured value is checked for stability (stability control). The [AR] status indicator is displayed. A progress bar is displayed and the display of the measured parameter flashes.
25. Wait for the measurement with stability control to be completed or terminate the stability control and take over the calibration value with **<ENTER>**.
The calibration display for the setting of the nominal buffer value appears.

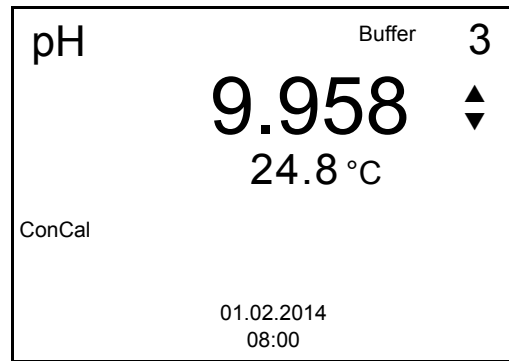

26. Set the nominal buffer value for the measured temperature with $\langle \blacktriangle \rangle \langle \blacktriangledown \rangle$.
27. Accept the set calibration value with $\langle \text{ENTER} \rangle$.
The calibration display for the next buffer appears (voltage display).
28. Use $\langle \text{M} \rangle$ to finish calibration or
Continue calibrating using the next buffer with $\langle \text{ENTER} \rangle$.



After the fifth buffer has been measured the calibration is automatically finished. Then the calibration record is displayed.

The calibration line is determined by linear regression.

5.2.5 Calibration points

Calibration can be performed using one to five buffer solutions in any order (single-point to five-point calibration). The meter determines the following values and calculates the calibration line as follows:

	Determined values	Displayed calibration data
1-point	<i>Asy</i>	<ul style="list-style-type: none"> ● Zero point = <i>Asy</i> ● Slope = Nernst slope (-59.2 mV/pH at 25 °C)
2-point	<i>Asy</i> <i>Slp.</i>	<ul style="list-style-type: none"> ● Zero point = <i>Asy</i> ● Slope = <i>Slp.</i>
3-point to 5-point	<i>Asy</i> <i>Slp.</i>	<ul style="list-style-type: none"> ● Zero point = <i>Asy</i> ● Slope = <i>Slp.</i> <p>The calibration line is calculated by linear regression.</p>



You can display the slope in the units, mV/pH or % (see section 7.1.1 CHANGING THE SETTINGS FOR PH MEASUREMENTS, page 38).

5.2.6 Calibration data



The calibration record is automatically transmitted to the interface after calibrating.

Displaying the calibration data

The calibration record of the last calibration is to be found under the menu item, **<F1> / [Menu] Calibration / Calibration record**. To open it, press the **<CAL__>** key in the measured value display.

Subsequently, you can transmit the displayed calibration data to the interface, e. g. to a PC, with **<F2>[USB output]**.





Displaying the calibration data storage

The calibration records of the last calibrations (up to 10) are available in the menu, **<F1>/[Menu] / Calibration / Calibration data storage** and in the menu, **<F1__>/[Menu] / Storage & config/Data storage / Calibration data storage**.

Menu item	Setting/function	Description
<i>Calibration / Calibration data storage /Display</i> or <i>Data storage / Calibration data storage /Display</i>	-	Displays the calibration record. Further options: <ul style="list-style-type: none"> ● Scroll through the calibration records with <▲><▼>. ● Output the displayed calibration record to the interface with <F2>/[USB output]. ● Quit the display with <F1>/[Back] or <ENTER>. ● Switch directly to the measured value display with <M>.
<i>Calibration / Calibration data storage / Output to USB</i> or <i>Data storage / Calibration data storage /Output to USB</i>	-	Outputs the calibration records to the interface.

Calibration evaluation

After calibrating, the meter automatically evaluates the calibration. The zero point and slope are evaluated separately. The worse evaluation of both is taken into account. The evaluation appears on the display and in the calibration record.

Display	Calibration record	Zero point [mV]	Slope [mV/pH]
	+++	-15 ... +15	-60,5 ... -58,0
	++	-20 ... <-15 or >+15 ... +20	>-58,0 ... -57,0
	+	-25 ... <-20 or >+20 ... +25	-61,0 ... <-60,5 or >-57,0 ... -56,0
	-	-30 ... <-25 or >+25 ... +30	-62,0 ... <-61,0 or >-56,0 ... -50,0
Clean the electrode according to the electrode operating manual			
<i>Error</i>	<i>Error</i>	-30 ... +30	-62,0 ... -50,0
Error elimination (see section 12 WHAT TO DO IF..., page 59)			

Calibration record (example)

```

pH 7310
Ser. no. 11292113

CALIBRATION pH
01.02.2014 15:55

Ser. no. 10501234
TECYSI
Buffer 1           4.01
Buffer 2           7.00
Buffer 3           10.01
Voltage 1          184.0 mV
Voltage 2           3.0 mV
Voltage 3          -177.0 mV
Temperatur 1       24.0 °C
Temperatur 2       24.0 °C
Temperatur 3       24.0 °C
Slope              -60.2 mV/pH
Asymmetry          4.0 mV
Sensor             +++

etc...

```

5.2.7 Continuous measurement control (CMC function)

The Continuous Measurement Control (CMC function) facilitates to evaluate the current measured value instantly and definitely.

After each successful calibration the scale of the pH measuring range is displayed in the measured value display. Here you can very clearly see whether or not the current measured value is in the calibrated part of the measuring range.

The following information is displayed:

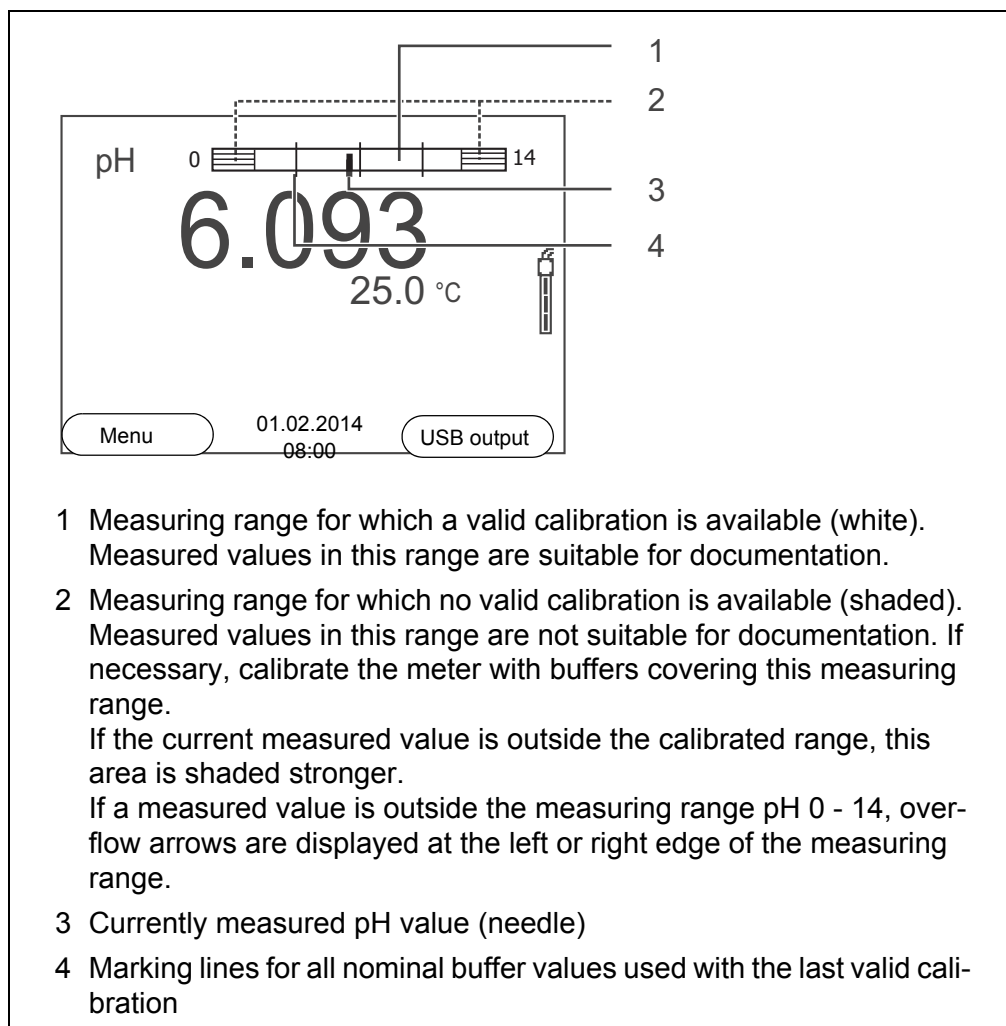

The limits of the calibrated range are determined by the buffers used for calibration:

Lower limit: Buffer with lowest pH value - 2 pH units
Upper limit: Buffer with highest pH value + 2 pH units

6 ORP voltage

6.1 Measuring

6.1.1 Measuring the ORP

When connecting an earthed PC, measurements cannot be performed in earthed media as the values would be incorrect. The USB interface is not galvanically isolated.

1. Connect the ORP electrode to the meter.
2. If necessary, select the mV display with **<M>**.
3. When measuring without temperature sensor:
Measure the temperature of the test sample and enter it with **<▲>** **<▼>**.
4. Immerse the ORP electrode in the test sample.
The measured value is checked for stability (automatic stability control).
The display of the measured parameter flashes.
5. Wait for a stable measured value.
The display of the measured parameter no longer flashes.

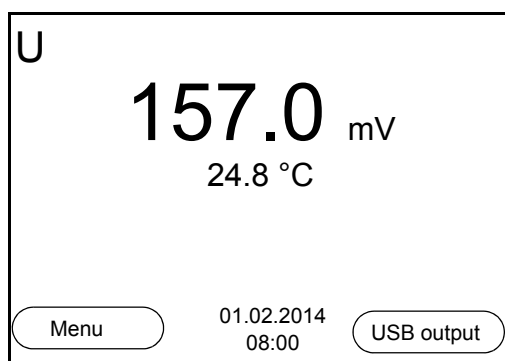

Stability control (AutoRead)

The stability control function (*AutoRead*) continually checks the stability of the measurement signal. The stability has a considerable impact on the reproducibility of measured values.

You can activate or switch off the automatic *Stability control* function (see section 7.1.1 CHANGING THE SETTINGS FOR PH MEASUREMENTS, page 38).

The measured parameter flashes on the display

- as soon as the measured value is outside the stability range
- when you switch over between the measured parameters with **<M>**.
- when the automatic *Stability control* is switched off.

Criteria for a stable measured value

The *Stability control* function checks whether the measured values are stable within the monitored time interval.

Measured parameter	Time interval	Stability in the time interval
ORP voltage	15 seconds	Δ : Better than 0.3 mV
Temperature	15 seconds	Δ : Better than 0.5 °C

The minimum duration until a measured value is assessed as stable is the monitored time interval. The actual duration is mostly longer.

Manually starting the stability control

You can start the *Stability control* manually at any time, irrespective of the setting for automatic *Stability control* (see section 7.1.1 CHANGING THE SETTINGS FOR PH MEASUREMENTS, page 38) in the *Measurement* menu.

1. Freeze the measured value with **<AR>**.
The [HOLD] status indicator is displayed.
2. Using **<ENTER>**, activate the *Stability control* function manually.
The [AR] status indicator appears while the measured value is assessed as not stable. A progress bar is displayed and the display of the measured parameter flashes.
The [HOLD][AR] status indicator appears as soon as a stable measured value is recognized. The progress bar disappears and the display of the measured parameter stops flashing.
The current measurement data is output to the interface. Measurement data meeting the stability control criterion is marked by AR.



You can prematurely terminate the *Stability control* function manually with **<ENTER>** at any time. If the *Stability control* function is prematurely terminated, the current measurement data are output to the interface without the AutoRead info.

3. Using **<ENTER>**, start a further measurement with *Stability control*.
or
Release the frozen measured value again with **<AR>**.
The display switches to the measured value display.
The [AR][HOLD] status display disappears.

Freezing the measured value (HOLD function)

With the HOLD function, you can freeze the current measured value. The displayed measured value stops changing until you switch the HOLD function off.



If the HOLD function is active, you can, e.g. start a manual measurement with stability control.

1. Freeze the measured value with **<AR>**.
The [HOLD] status indicator is displayed.

2. Release the frozen measured value again with **<AR>**.
The HOLD function is switched off.
The [HOLD] status display disappears.

6.1.2 Measuring the temperature

For reproducible ORP measurements, it is essential to measure the temperature of the test sample.

You have the following options to measure the temperature:

- Automatic measurement of the temperature by the temperature sensor (NTC30 or Pt1000) integrated in electrode.
- Measurement by an external temperature sensor.
- Manual determination and input of the temperature.

The measuring instrument recognizes whether a suitable sensor is connected and automatically switches on the temperature measurement.

The display of the temperature indicates the active temperature measuring mode:

Temperature sensor	Resolution of the temp. display	Temp. measurement
yes	0.1 °C	Automatic with temperature sensor
-	1 °C	Manual

If you wish to measure (or calibrate) without temperature sensor, proceed as follows:

1. Measure the current temperature of the test sample.
2. Set the temperature value with **<▲><▼>**.
or
In the **<F1>/[Menu]/Man. temperature** menu, set the temperature value with **<▲><▼>**.

6.2 ORP calibration



ORP electrodes are not calibrated. You can, however, check ORP electrodes by measuring the ORP of a test solution and comparing the value with the nominal value.

7 Settings

7.1 Measurement settings

7.1.1 Changing the settings for pH measurements

The settings are made in the menu for calibration and measurement settings of the pH/ORP measurement. To open the settings, display the required parameter in the measured value display and press the **<F1>/[menu]** or **<ENTER>** key. After completing the settings, switch to the measured value display with **<M>**.

Default settings are printed in **bold**.

Menu item	Possible setting	Description
<i>Calibration / Calibration record</i>	-	Displays the calibration record of the last calibration.
<i>Calibration / Calibration data storage / Display</i>	-	Displays the calibration record. Further options: <ul style="list-style-type: none"> ● Scroll through the calibration records with <▲><▼>. ● Output the displayed calibration record to the interface with <F2>/[USB output]. ● Output all calibration records to the interface with <F2__>/[USB output]. ● Quit the display with <F1>/[Back] or <ENTER>. ● Switch directly to the measured value display with <M>.
<i>Calibration / Calibration data storage / Output to USB</i>	-	Outputs the calibration records to the interface.
<i>Calibration / Serial number (probe)</i>		Entry of the serial number of the connected sensor. The serial number is output in the calibration record. <ul style="list-style-type: none"> ● Change the content of the highlighted position with <▲><▼>. ● Go to the next position with <F2>/[▶]. ● When the serial number has been completely entered, confirm with <ENTER>.

Menu item	Possible setting	Description
<i>Calibration / Buffer</i>	TEC <i>ConCal</i> <i>NIST/DIN</i> ...	Buffer sets to be used for pH calibration (see section 5.2 CALIBRATION, page 25).
<i>Calibration / One point calibration</i>	Yes No	Quick calibration with 1 buffer
<i>Calibration / Calibration interval</i>	1 ... 7 ... 999 d	<i>Calibration interval</i> for the pH electrode (in days). The meter reminds you to calibrate regularly by the flashing sensor symbol in the measuring window.
<i>Calibration / Unit for slope</i>	mV/pH %	Unit of the slope. The % display refers to the Nernst slope of -59.2 mV/pH (100 x determined slope/Nernst slope).
<i>Man. temperature</i>	-25 ... +25 ... +130 °C	Entry of the manually determined temperature. For measurements without temperature sensor only.
<i>Temperature unit</i>	°C °F	Temperature unit, degrees Celsius or degrees Fahrenheit. All temperatures are displayed with the selected unit.
<i>Resolution pH</i>	0.001 0.01 0.1	Resolution of the pH display
<i>Stability control</i>	On Off	Switches on or off the automatic stability control during measurement (see section 5.1.1 MEASURING THE PH VALUE, page 22)
<i>Reset</i>	-	Resets all sensor settings to the delivery condition (see section 7.4.1 RESETTING THE MEASUREMENT SETTINGS, page 44).

7.1.2 Buffer sets for calibration

You can use the buffer sets quoted in the table for an automatic calibration. The pH values are valid for the specified temperature values. The temperature dependence of the pH values is taken into consideration during the calibration.

No.	Buffer set *	pH values	at
1	<i>ConCal</i>	Any	Any
2	<i>NIST/DIN</i> DIN buffers according to DIN 19266 and NIST Traceable Buffers	1.679 4.006 6.865 9.180 12.454	25 °C
3	<i>TEC</i> WTW Technical buffers	2.000 4.010 7.000 10.011	25 °C
4	<i>Merck 1*</i>	4.000 7.000 9.000	20°C
5	<i>Merck 2 *</i>	1.000 6.000 8.000 13.000	20°C
6	<i>Merck 3 *</i>	4.660 6.880 9.220	20°C
7	<i>Merck 4 *</i>	2.000 4.000 7.000 10.000	20°C
8	<i>Merck 5 *</i>	4.010 7.000 10.000	25 °C
9	<i>DIN 19267</i>	1.090 4.650 6.790 9.230	25 °C
10	<i>Mettler Toledo USA *</i>	1.679 4.003 7.002 10.013	25 °C
11	<i>Mettler Toledo EU *</i>	1.995 4.005 7.002 9.208	25 °C
12	<i>Fisher *</i>	2.007 4.002 7.004 10.002	25 °C

No.	Buffer set *	pH values	at
13	<i>Fluka BS *</i>	4.006 6.984 8.957	25 °C
14	<i>Radiometer *</i>	1.678 4.005 7.000 9.180	25 °C
15	<i>Baker *</i>	4.006 6.991 10.008	25 °C
16	<i>Metrohm *</i>	3.996 7.003 8.999	25 °C
17	<i>Beckman *</i>	4.005 7.005 10.013	25 °C
18	<i>Hamilton Duracal *</i>	4.005 7.002 10.013	25 °C
19	<i>Precisa *</i>	3.996 7.003 8.999	25 °C
20	<i>Reagecon TEC *</i>	2.000 4.010 7.000 10.000	25 °C
21	<i>Reagecon 20 *</i>	2.000 4.000 7.000 10.000 13.000	20°C
22	<i>Reagecon 25 *</i>	2.000 4.000 7.000 10.000 13.000	25 °C

No.	Buffer set *	pH values	at
23	<i>Chemsolute</i> *	2,000 4,000 7,000 10,000	20 °C
24	<i>USABlueBook</i> *	4,000 7,000 10,000	25 °C
25	<i>YSI</i> *	4.000 7.000 10.000	25 °C

* Brand names or trade names are trademarks of their respective owners protected by law.



The buffers are selected in the menu, pH / <F1>/[Menu] / *Calibration* / *Buffer* (see 7.1.1 CHANGING THE SETTINGS FOR PH MEASUREMENTS, PAGE 38).

7.1.3 Calibration interval

The calibration evaluation is displayed as a sensor symbol.

The sensor symbol flashes after the adjusted calibration interval has expired. It is still possible to measure.



To ensure the high measuring accuracy of the measuring system, calibrate after the calibration interval has expired.

Setting the calibration interval

The calibration interval is set to 7 days in the factory. You can change the interval (1 ... 999 days):

1. Open the menu for measurement settings with [Menu]<F1>.
2. In the *Calibration* / *Calibration interval* menu, set the calibration interval with <▲><▼>.
3. Confirm the setting with <ENTER>.
4. Quit the menu with <M>.

7.2 Settings for ORP measurements

The settings are made in the menu for calibration and measurement settings of the pH/ORP measurement. To open the settings, display the required parameter in the measured value display and press the <F1>/[menu] or <ENTER> key. After completing the settings, switch to the measured value display with <M>.

Default settings are printed in **bold**.

Menu item	Possible setting	Description
<i>Man. temperature</i>	-25 ... +25 ... +130 °C	Entry of the manually determined temperature. For measurements without temperature sensor only.
<i>Temperature unit</i>	°C °F	Temperature unit, degrees Celsius or degrees Fahrenheit. All temperatures are displayed with the selected unit.
<i>Resolution mV</i>	0.1 1	Resolution of the mV display
<i>Stability control</i>	On Off	Switches on or off the automatic stability control during measurement (see section Stability control (AutoRead) & HOLD function, page 22)
<i>Reset</i>	-	Resets all sensor settings to the delivery condition (see section 7.4.1 RESETTING THE MEASUREMENT SETTINGS, page 44).

7.3 Sensor-independent settings

7.3.1 System

To open the *Storage & config* menu, press the <F1__>[Menu] key in the measured value display. After completing the settings, switch to the measured value display with <M>.

Default settings are printed in **bold**.

Menu item	Possible setting	Description
<i>System / General / Language</i>	<i>Deutsch</i> English (further)	Selects the menu language
<i>System / General / Beep</i>	On Off	Switches on/off the beep on keystroke
<i>System / General / Illumination</i>	Auto On Off	Switches the display illumination on/off
<i>System / General / Contrast</i>	0 ... 50 ... 100 %	Changing the display contrast
<i>System / General / Switchoff time</i>	10 min ... 1h ... 24 h	Adjusts the switch-off time

Menu item	Possible setting	Description
<i>System / Interface / Baud rate</i>	1200, 2400, 4800 , 9600, 19200	Baud rate of the data interface
<i>System / Interface / Output format</i>	ASCII CSV	Output format for data transmission (see section 9 TRANSMITTING DATA (USB INTERFACE), page 52)
<i>System / Interface / Decimal separator</i>	Dot (xx.x) Comma (xx,x)	Decimal separator
<i>System / Interface / Output header</i>		Output of a header for <i>Output format</i> : CSV
<i>System / Printer</i>		Settings for the integrated printer of the pH 7310 P. For details, see section 10 PRINTER (ONLY PH 7310P), page 54
<i>System / Clock</i>	<i>Date format</i> <i>Date</i> <i>Time</i>	Time and date settings (see section 4.4.6 EXAMPLE 2 ON NAVIGATION: SETTING THE DATE AND TIME, page 20)
<i>System / Service information</i>		Hardware version and software version of the meter are displayed.
<i>System / Reset</i>	-	Resets the system settings to the delivery condition (see section 7.4.2 RESETTING THE SYSTEM SETTINGS, page 45).

7.3.2 Data storage

This menu contains all functions to display, edit and erase stored measured values and calibration records (see section 8 DATA STORAGE, page 46).

7.4 Reset

You can reset (initialize) all sensor settings and sensor-independent settings separately from each other.

7.4.1 Resetting the measurement settings



The calibration data are reset to the default settings together with the measuring parameters. Recalibrate after performing a reset.

The following settings for pH measurements are reset to the default settings with the *Reset* function:

Setting	Default settings
<i>Buffer</i>	<i>TEC</i>
<i>Cal. interval</i>	7 d
<i>Unit for slope</i>	mV/pH
<i>Measured parameter</i>	pH
<i>Resolution pH</i>	0.001
<i>Resolution mV</i>	0.1
<i>Asymmetry</i>	0 mV
<i>Slope</i>	-59.2 mV
<i>Man. temperature</i>	25 °C
<i>One point calibration</i>	No
<i>Stability control</i>	On
<i>Temperature unit</i>	°C

The sensor settings are reset under the *Reset* menu item in the menu for calibration and measurement settings. To open it, press the <F1>/[Menu] or <ENTER> key in the measured value display.

7.4.2 Resetting the system settings

The following system settings can be reset to the default condition:

Setting	Default settings
<i>Language</i>	English
<i>Beep</i>	On
<i>Baud rate</i>	4800 Baud
<i>Output format</i>	ASCII
<i>Contrast</i>	50 %
<i>Illumination</i>	Auto
<i>Switchoff time</i>	1 h

The system settings are reset in the menu, *Storage & config / System / Reset*. To open the *Storage & config* menu, press the <F1__>[Menu] key in the measured value display.

8 Data storage

You can transmit measured values (datasets) to the data storage:

- Manual storage (see section 8.1 MANUAL STORAGE, page 46)
- Automatic storage at intervals (see section 8.2 AUTOMATIC STORAGE AT INTERVALS, page 47)

Each storage process transmits the current dataset to the interface at the same time.

8.1 Manual storage

You can transmit a measurement dataset to the data storage as follows. The dataset is at the same time output to the interface:

1. Press the **<STO>** key shortly.
The menu for manual storage appears.

Manual data storage 4 From 500

01.02.2014 11:24:16
pH 7.000 24.8 °C AR +++

ID number: 1

Continue

Back 01.02.2014
08:00

2. If necessary, change and confirm the ID number (1 ... 10000) with **<▲><▼>** and **<ENTER>**.
The dataset is stored. The meter switches to the measured value display.

If the storage is full The following window appears if all 500 storage locations are occupied:

Warning

Data storage full. Erase?

Yes

No

Back 01.02.2014
08:00

You have the following options:

- To erase the entire storage, confirm *Yes*.
- To cancel the storage process and switch to the measured value display, confirm *No*. Then you can e.g. transmit the stored data to a PC (see section 8.3.1 EDITING THE MEASURED VALUE STORAGE, page 49) and subsequently erase the storage (see section 8.3.2 ERASING THE MEASUREMENT DATA STORAGE, page 51).

8.2 Automatic storage at intervals

The storage interval (*Interval*) determines the time interval between automatic storage processes. Each storage process transmits the current dataset to the interface at the same time.

Configuring the automatic storage function

1. Press the **<STO__>** key.
The menu for automatic storage appears.

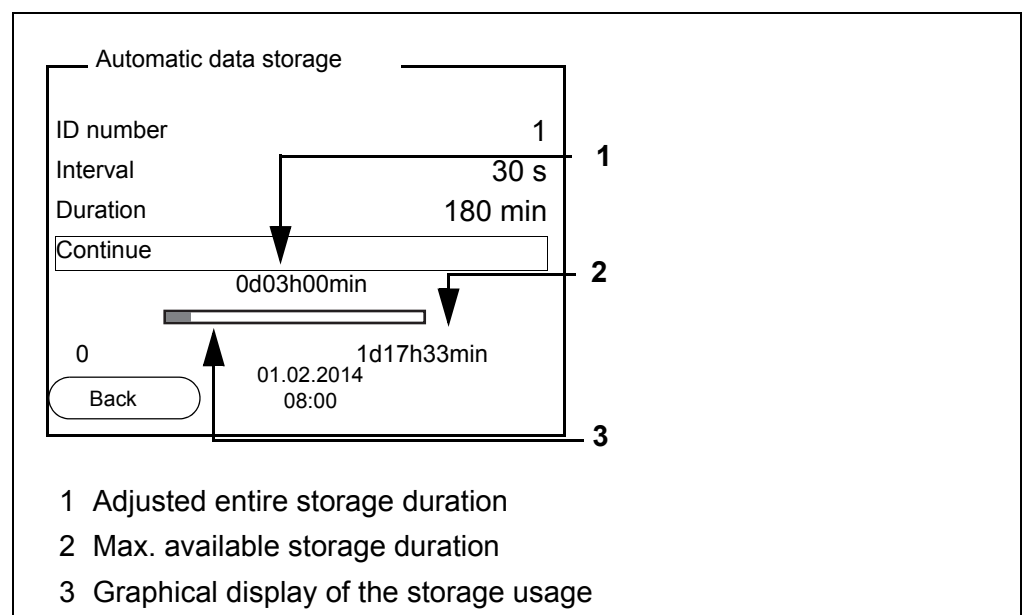

Settings You can configure the automatic storage function with the following settings:

Menu item	Possible setting	Description
<i>ID number</i>	1 ... 10000	ID number for the dataset series.
<i>Interval</i>	1 s, 5 s, 10 s, 30 s, 1 min, 5 min, 10 min, 15 min, 30 min, 60 min	Storage interval. The lower limit of the storage interval can be restricted by the number of free storage locations. The upper limit is restricted by the storage duration.
<i>Duration</i>	1 min ... x min	Storage duration. Specifies after which time the automatic storage should be terminated. The lower limit of the storage duration is restricted by the storage interval. The upper limit is restricted by the number of free storage locations.

Starting the automatic storage function

To start the automatic storage function, select *Continue* with **<▲><▼>** and confirm with **<ENTER>**. The meter switches to the measured value display.

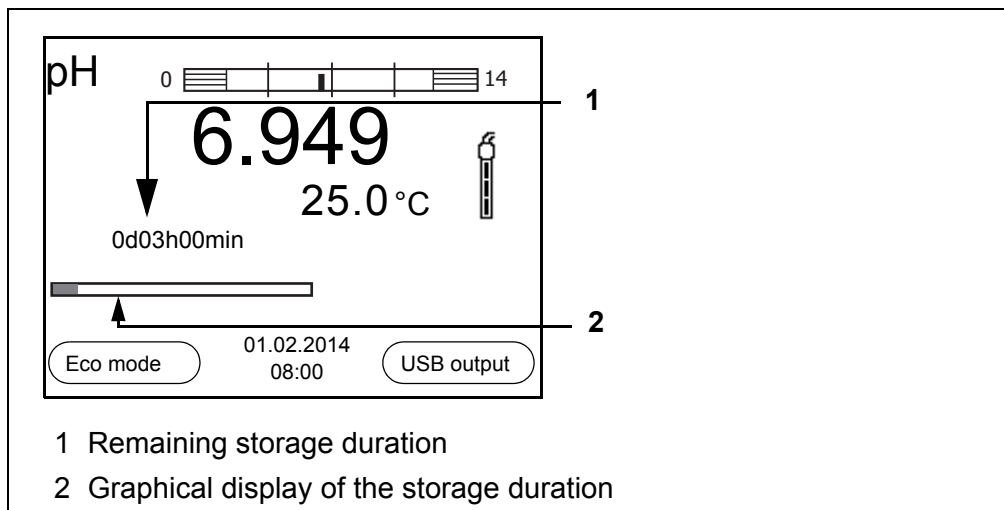

The active automatic storage function can be recognized by the progress bar in the function display. The progress bar indicates the remaining storage duration.



If the automatic storage function is activated, only the following keys are active: Softkeys, **<M>**, **<STO__>** and **<On/Off>**. The other keys and the automatic switch-off function are deactivated.

Energy saving mode ([Eco mode])

If the automatic storing function is active, the meter provides an energy saving mode ([Eco mode]) to avoid unnecessary energy consumption. The energy saving mode switches off functions of the meter that are not required for the

automatic storage of measurement data (such as the display). By pressing any key the energy saving mode is switched off again.

Terminating the automatic storage function prematurely

Proceed as follows to switch off the automatic storage function before the adjusted storage duration has expired:

1. Press the **<STO__>** key.
The following window appears.

The image shows a rectangular dialog box with a title bar that says "Warning". Inside the box, the text "Stop automatic storage?" is displayed. Below this text are two options: "Yes" and "No". The "No" option is currently selected, indicated by a horizontal line underneath it. At the bottom left of the dialog box is a button labeled "Back". At the bottom right, the date and time "01.02.2014 08:00" are displayed.

2. Using **<▲><▼>**, select Yes and confirm with **<ENTER>**.
The meter switches to the measured value display.
The automatic storage function is terminated.

8.3 Measurement data storage

8.3.1 Editing the measured value storage

The contents of the manual or automatic measurement data storage can be shown on the display and output to the interface.

Each of the measurement data storages has a function to erase the entire contents.

Editing the data storage

The storage is edited in the menu, *Storage & config / Data storage*. To open the *Storage & config* menu, press the **<F1__>**[Menu] key in the measured value display.

Open the manual or automatic storage directly with the **<RCL>** or **<RCL__>** key.



The settings are explained here using the manual storage as an example. The same settings and functions are available for the automatic storage.

Settings

Menu item	Setting/ function	Description
<i>Data storage / Manual data storage / Display</i>	-	Displays all measurement datasets page by page. Further options: <ul style="list-style-type: none"> ● Scroll through the datasets with <▲><▼>. ● Output the displayed dataset to the interface with <F2>/[USB output]. ● Quit the display with <F1>/[Back].
<i>Data storage / Manual data storage / Erase</i>	-	Erases the entire manual measurement data storage. All calibration data remains stored when this action is performed.
<i>Data storage / Manual data storage / Output to USB</i>	-	Outputs all stored measurement data to the interface.

Display presentation of a dataset

Manual data storage	3 of 64	◆
01.02.2014 11:24:16 ID number: 2		
pH 7.000 24.8 °C AR +++		
Back	01.02.2014 08:00	USB output

Representation of a dataset (USB output)

01.02.2014 09:56:20 pH 7310 Ser. no. 08502113
ID number 2
pH 6.012 24.8 °C, AR, S: +++

01.02.2014 10:56:20 pH 7310 Ser. no. 08502113
ID number 2
pH 6.012 24.8 °C, AR, S: +++

etc...

Quitting the display

To quit the display of stored measurement datasets, you have the following options:

- Switch directly to the measured value display with **<M>**.
- Quit the display and move to the next higher menu level with **<F1>/[Back]**.

8.3.2 Erasing the measurement data storage

Erasing the measurement data storage (see section 8.3.1 EDITING THE MEASURED VALUE STORAGE, page 49).

8.3.3 Measurement dataset

A complete dataset consists of:

- ID number
- Date/time
- Measured value of the connected sensor
- Measured temperature value of the connected sensor or manually set temperature
- AutoRead info: The *AR* indicator appears with the measured value if the AutoRead criterion was met while storing (stable measured value). Otherwise, there is no *AR* indicator.
- Calibration evaluation: +++, ++, +, -, or no evaluation

8.3.4 Storage locations

The pH 7310 meter has two measurement data storages. The measured values recorded either manually or automatic are stored separately in individual measurement data storages.

Storage	Maximum number of datasets
<i>Manual data storage</i>	500
<i>Automatic data storage</i>	5000

9 Transmitting data (USB interface)

9.1 Options for data transmission

Via the USB interface you can transmit data to a PC. The following table shows which data are transmitted to the interface in which way:

Data	Control	Operation / description
Current measured values of all connected sensors	Manual	<ul style="list-style-type: none"> ● With <F2>[USB output]. ● Simultaneously with every manual storage process (see section 8.1 MANUAL STORAGE, page 46).
	Automatic, at intervals	<ul style="list-style-type: none"> ● With <F2__>[USB output]. Then you can set the transmission interval. ● Simultaneously with every automatic storage process (see section 8.2 AUTOMATIC STORAGE AT INTERVALS, page 47).
Stored measured values	Manual	<ul style="list-style-type: none"> ● Displayed dataset with <F2>[USB output] after calling up from the storage. ● All datasets with the <i>Output to USB</i> function. (see section 8.3.1 EDITING THE MEASURED VALUE STORAGE, page 49).
Calibration records	Manual	<ul style="list-style-type: none"> ● Calibration record with <F2>[USB output] (see section 5.2.6 CALIBRATION DATA, page 32).
	Automatic	<ul style="list-style-type: none"> ● At the end of a calibration procedure.



The following rule applies: With the exception of the menus, shortly pressing the **<F2>**[USB output] key generally outputs the display contents to the interface (displayed measured values, measurement datasets, calibration records).

9.2 Connecting a PC

Connect the pH 7310 to the PC via the USB interface.

NOTE

When connecting an earthed PC, measurements cannot be performed in earthed media as the values would be incorrect. The USB interface is not galvanically isolated.

Installation of the USB driver on the PC

System requirements of the PC for installation of the USB driver:

- PC with Pentium processor or higher with at least one free USB connection and CD-ROM drive
- Windows 2000, XP, Vista.

1. Insert the supplied installation CD in the CD drive of your PC.
2. Install the driver from the CD.
Follow the Windows installation instructions as necessary.
3. Connect the pH 7310 to the PC via the USB interface.
The meter is listed as a virtual COM interface among the connections in the Windows instrument manager.

9.3 MultiLab Importer

With the aid of the MultiLab Importer software, you can record and evaluate measuring data with a PC.



More detailed information can be found in the MultiLab Importer operating manual.

10 Printer (only pH 7310P)

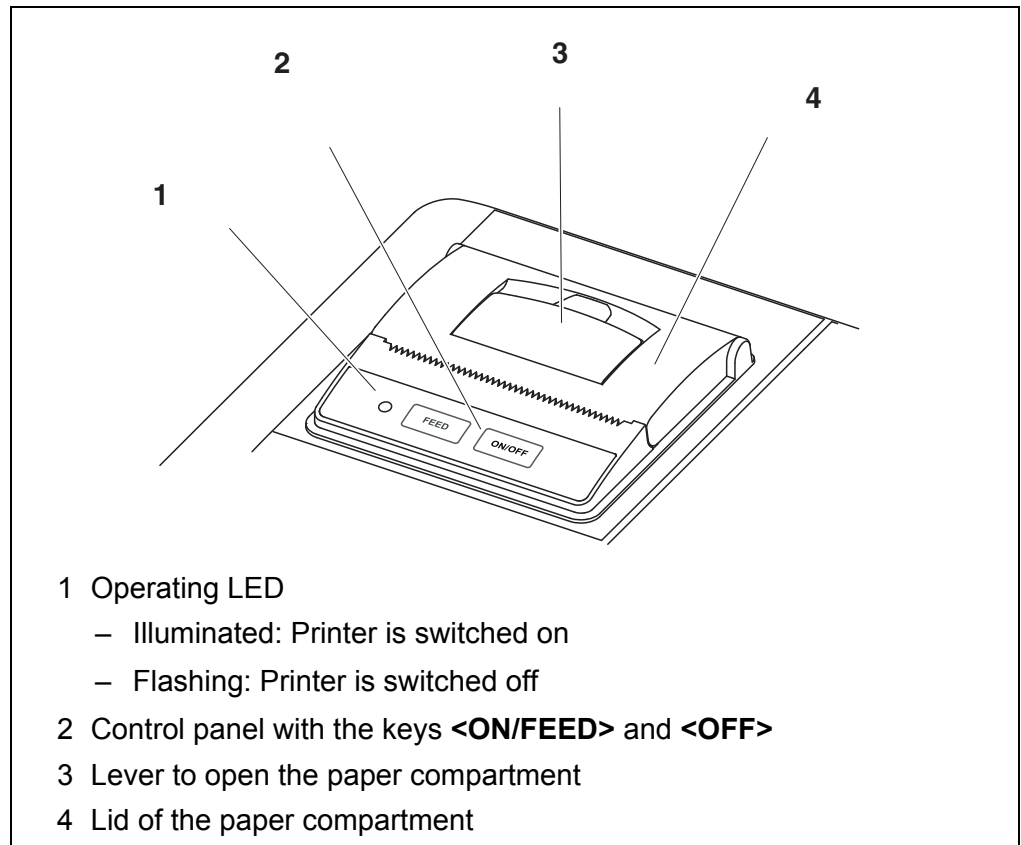

10.1 Commissioning / switching the printer on or off

Switching on the printer

1. Connect the power pack to the pH 7310 P.
The LED lights up green. The printer is ready for operation.
or
If the printer was switched off (LED flashing):
Switch on the printer with **<OFF>**.
The LED lights up green. The printer is ready for operation.



If there is a USB connection (such as to a PC) the data are output only to the PC.

Switching off the printer

1. Switch off the printer with **<OFF>**.
The LED flashes. The printer is switched off.

10.2 Operation / printing

Data are only output to the printer if the following conditions are met

- Data are transmitted manually or automatically (see section 9.1 OPTIONS FOR DATA TRANSMISSION, page 52)
- the printer is switched on (LED illuminated)
- there is no USB connection.

10.3 Printer settings

To open the *Storage & config* menu, press the <F1_>[Menu] key in the measured value display. After completing the settings, switch to the measured value display with <M>.

Default settings are printed in **bold**.

Menu item	Possible setting	Description
<i>System / Printer / Font size</i>	12x20 8x16 7x16	Select the font size for the printer A print sample (character set of the printer) to view the available font sizes can be printed with <OFF_>.
<i>System / Printer / Print test page</i>	-	The printer prints the meter information from the <i>System / Service information</i> menu. The current printer settings are used for the printout.

10.4 Maintenance

10.4.1 Changing the roll of paper (thermal paper)

1. Pull the lever (3) until the lid (4) of the paper compartment opens.
2. If necessary, remove any remains of the old roll of paper.
3. Insert the new roll of paper. The start of the paper should poke out of the paper compartment.
4. Close the lid (4) of the paper compartment so that it clicks into place.
5. If necessary, move the printer paper forward with <ON/FEED>.



Use original WTW rolls of paper only.

You will find information on this in the WTW catalog LABORATORY AND FIELD INFORMATION or on the Internet.

The thermal paper will remain legible for at least 7 years if stored appropriately.

10.5 What to do if... / printer

Integrated printer does not print	Cause	Remedy
	– Printer switched off (LED flashing)	– Switch on the printer (LED illuminated)
	– No power pack connected	– Connect the power pack
	– USB cable connected	– Disconnect the USB cable from the meter
	– Function "automatic storing at intervals" with long intervals is switched on	– Switch off the function (see section 8.2 AUTOMATIC STORAGE AT INTERVALS, page 47)
	– No paper available	– Insert a roll of paper
Printer operating - paper not being printed	Cause	Remedy
	– Paper inserted the wrong way up	– Turn the roll of paper around and insert it with the other side upwards
Integrated printer prints automatically	Cause	Remedy
	– The function "Automatic storage at intervals" or "Transmit data automatic at intervals" is switched on	– Switch off the function (see section 8.2 AUTOMATIC STORAGE AT INTERVALS, page 47 or section 9.1 OPTIONS FOR DATA TRANSMISSION, page 52)

11 Maintenance, cleaning, disposal

11.1 Maintenance

11.1.1 General maintenance activities

The only maintenance activity required is replacing the batteries.



See the relevant operating manuals of the electrodes for instructions on maintenance.

11.1.2 Replacing the batteries



You can operate the meter either with normal batteries or with rechargeable batteries (Ni-MH). In order to charge the batteries, an external charging device is required.

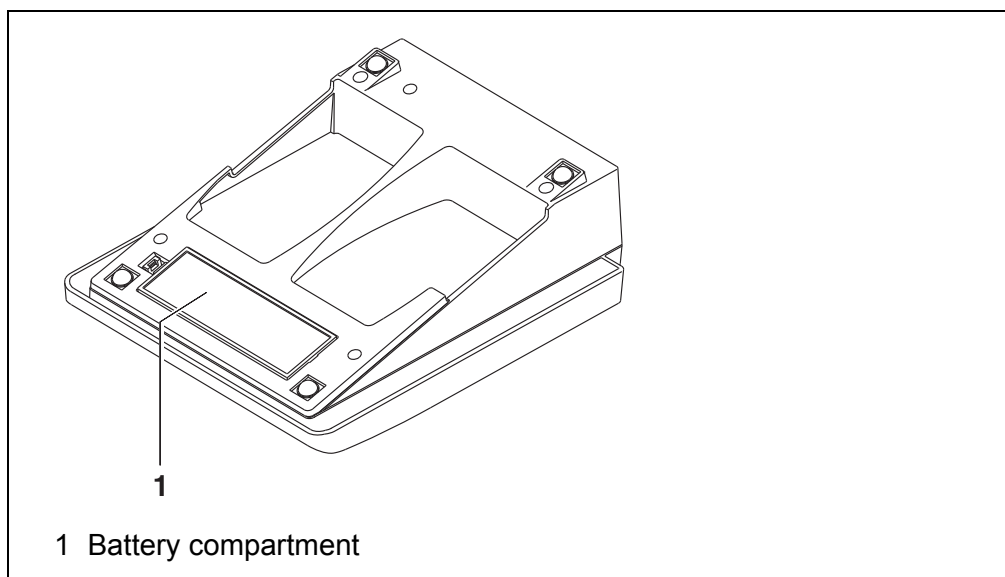

1. Open the battery compartment (1) on the underside of the meter.
2. Remove the four batteries from the battery compartment.
3. Place four new batteries (type Mignon AA) in the battery compartment.



CAUTION

Make sure that the poles of the batteries are positioned correctly.

The \pm -signs on the batteries must correspond to the \pm signs in the battery compartment.

4. Close the battery compartment (1).
The date (day) flashes on the display.
5. Set the date and time (see section 4.4.6 EXAMPLE 2 ON NAVIGATION:
SETTING THE DATE AND TIME, page 20)



Dispose of used batteries according to the local regulations of your country.

End users within the European Union are obligated to return used batteries (even ecologically compatible ones) to a collection point set up for recycling purposes.

Batteries are marked with the crossed-out waste container symbol. Therefore, they may not be disposed with the domestic waste.

11.2 Cleaning

Occasionally wipe the outside of the measuring instrument with a damp, lint-free cloth. Disinfect the housing with isopropanol as required.



CAUTION

The housing is made of synthetic material (ABS). Thus, avoid contact with acetone or similar detergents that contain solvents. Remove any splashes immediately.

11.3 Packing

This meter is sent out in a protective transport packing.
We recommend: Keep the packing material. The original packing protects the meter against damage during transport.

11.4 Disposal

At the end of its operational lifetime, the meter must be returned to the disposal or return system statutory in your country. If you have any questions, please contact your supplier.

12 What to do if...

12.1 pH/ORP



More information and instructions on cleaning and exchange of sensors are given in the documentation of your sensor.

Error message
OFL, UFL

The measured value is outside the measuring range.

Cause	Remedy
pH electrode:	
– Air bubble in front of the junction	– Remove air bubble
– Air in the junction	– Extract air or moisten junction
– Cable broken	– Replace electrode
– Gel electrolyte dried out	– Replace electrode
– Measured value outside the measuring range of the meter	– Use suitable electrode

Error message,
Error

Cause	Remedy
pH electrode:	
– The values determined for zero point and slope of the electrode are outside the allowed limits.	– Recalibrate
– Junction contaminated	– Clean junction
– Electrode broken	– Replace electrode
Buffer solutions:	
– Wrong buffer solutions	– Change calibration procedure
– Buffer solutions too old	– Use only once. Note the shelf life
– Buffer solutions depleted	– Change solutions

No stable measured value	Cause	Remedy
	pH electrode:	
	– Junction contaminated	– Clean junction
	– Membrane contaminated	– Clean membrane
	Test sample:	
	– pH value not stable	– Measure with air excluded if necessary
	– Temperature not stable	– Temper if necessary
	Electrode + test sample:	
	– Conductivity too low	– Use suitable electrode
	– Temperature too high	– Use suitable electrode
	– Organic liquids	– Use suitable electrode
Obviously incorrect measured values	Cause	Remedy
	pH electrode:	
	– pH electrode unsuitable	– Use suitable electrode
	– Temperature difference between buffer and test sample too great	– Adjust temperature of buffer or sample solutions
	– Measurement procedure not suitable	– Follow special procedure

12.2 General information

Sensor symbol flashes	Cause – Calibration interval expired	Remedy – Recalibrate the measuring system
Display 	Cause – Batteries almost empty	Remedy – Replace the batteries (see section 11.1 MAINTENANCE, page 57)
Instrument does not react to keystroke	Cause – Operating condition undefined or EMC load unallowed	Remedy – Processor reset: Press the <ENTER> and <On/Off> key simultaneously
You want to know which software version is in the meter	Cause – E. g., a question by the service department	Remedy – Switch on the meter. Open the menu, <F1_>/ [Menu] / Storage & config / SystemService information . The instrument data are displayed.

13 Technical data

13.1 Measuring ranges, resolution, accuracy

Measuring ranges, resolution

Parameter	Measuring range	Resolution
pH	-2.0 ... +20.0	0.1
	-2.00 ... +20.00	0.01
	-2.000 ... +19.999	0.001
U [mV]	-1200.0 ... +1200.0	0.1
	-2500 ... +2500	1
T [°C]	-5.0 ... +105.0	0.1
T [°F]	23.0 ... +221.0	0.1

Manual temperature input

Parameter	Range	Increment
T _{manual} [°C]	-25 ... +130	1
T _{manual} [°F]	-13 ... +266	1

Accuracy (± 1 digit)

Parameter	Accuracy	Temperature of the test sample
pH / range *		
-2.0 ... +20.0	± 0.1	+15 °C ... +35 °C
-2.00 ... +20.00	± 0.01	+15 °C ... +35 °C
-2.000 ... +19.999	± 0.005	+15 °C ... +35 °C
U [mV] / range		
-2500 ... +2500	± 1	+15 °C ... +35 °C
-1200.0 ... +1200.0	± 0.3	+15 °C ... +35 °C
T [°C] / temperature sensor		
NTC 30	± 0.1	
PT 1000	± 0.1	

* when measuring in a range of ± 2 pH around a calibration point



The accuracy values specified here apply exclusively to the meter. The accuracy of the electrodes and buffer solutions has to be taken into account additionally.

13.2 General data

Dimensions	pH 7310:	Approx. 230 x 190 x 80 mm
	pH 7310 P:	Approx. 280 x 230 x 80 mm
Weight	pH 7310:	Approx. 0.8 kg
	pH 7310 P:	Approx. 1.0 kg
Mechanical structure	Type of protection	IP 43
Electrical safety	Protective class	III
Test certificates	CE	
Ambient conditions	Storage	-25 °C ... +65 °C
	Operation	+5 °C ... +55 °C With the power pack connected: +5 °C ... +40 °C
	Admissible relative humidity	Yearly mean: < 75 % 30 days/year: 95 % Other days: 85 %
Power supply	Batteries	4 x 1.5 V alkali-manganese batteries, type AA
	Rechargeable batteries	4 x 1.2 V NiMH rechargeable batteries, type AA (no charging function)
	Operational life	Up to 1000 h without / 150 h with illumination
	Power pack	Kuantech Co. Ltd. KSAC 0900110W1UV-1 Input: 100 ... 240 V ~ / 50 ... 60 Hz / 270 mA Output: 9 V = / 1.1 A Connection max. overvoltage category II Primary plugs contained in the scope of delivery: Euro, US, UK and Australian.
Sensor input	Input resistance	> 5 * 10 ¹² ohm
	Input current	< 1 * 10 ⁻¹² A
USB interface	Type	USB 1.1 USB B (device), data output
	Baud rate	Adjustable: 1200, 2400, 4800, 9600, 19200 Baud
	Data bits	8
	Stop bits	2
	Parity	None
	Handshake	RTS/CTS
	Cable length	max. 3 m

**Guidelines
and norms used**

EMC	EC directive 2004/108/EC EN 61326-1 EN 61000-3-2 EN 61000-3-3 FCC Class A
Meter safety	EC directive 2006/95/EC EN 61010-1
IP protection class	EN 60529

FCC Class A Equipment Statement

Note: This equipment has been tested and found to comply with the limits for a Class A digital device, pursuant to Part 15 of the FCC Rules. These limits are designed to provide reasonable protection against harmful interference when the equipment is operated in a commercial environment. This equipment generates, uses, and can radiate radio frequency energy and, if not installed and used in accordance with the instruction manual, may cause harmful interference to radio communications. Operation of this equipment in a residential area is likely to cause harmful interference in which case the user will be required to correct the interference at his own expense. Changes or modifications not expressly approved by the manufacturer could void the user's authority to operate the equipment.

14 Firmware update

Available firmware updates are provided on the Internet.

With the firmware update program and a PC you can update the firmware of the pH 7310 to the newest version.

For the update you have to connect the meter to a PC.

For the update via the USB interface, the following is required:

- a free USB interface (virtual COM port) on the PC
- the driver for the USB interface (on the enclosed CD-ROM)
- the USB cable (included in the scope of delivery of the pH 7310).

1. Install the downloaded firmware update on a PC.
An update folder is created in the Windows start menu.
If an update folder already exists for the meter (or meter type), the new data is displayed there.
2. In the windows start menu, open the update folder and start the firmware update program.
3. Using the USB interface cable, connect the pH 7310 to a USB interface (virtual COM port) of the PC.
4. Switch on the pH 7310.
5. In the firmware update program, start the update process with OK.
6. Follow the instructions of the firmware update program.
During the programming process, a corresponding message and a progress bar (in %) are displayed.
The programming process takes approx. three minutes. A terminatory message is displayed after a successful programming process. The firmware update is completed.
7. Disconnect the pH 7310 from the PC.
The pH 7310 is ready for operation again.

After switching the meter off and on you can check whether the meter has taken over the new software version (see YOU WANT TO KNOW WHICH SOFTWARE VERSION IS IN THE METER, PAGE 61).

15 Glossary

pH/ORP

Asymmetry	see zero point
Electromotive force of an electrode	The electromotive force U of the combination electrode is the measurable electromotive force of an electrode in a solution. It equals the sum of all the galvanic voltages of the combination electrode. Its dependency on the pH results in the electrode function, which is characterized by the parameters, slope and zero point.
Junction	The junction is a porous body in the housing wall of reference electrodes or electrolyte bridges. It arranges the electrical contact between two solutions and makes the electrolyte exchange more difficult. The expression, junction, is also used for ground or junction-less transitions.
ORP voltage	The ORP is caused by oxidizing or reducing substances dissolved in water if these substances become effective on an electrode surface (e. g. a gold or platinum surface).
pH value	The pH value is a measure of the acidic or basic effect of an aqueous solution. It corresponds to the negative decadic logarithm of the molal hydrogen ions activity divided by the unit of the molality. The practical pH value is the value of a pH measurement.
Potentiometry	Name of a measuring technique. The signal (depending on the measured parameter) of the electrode is the electrical potential. The electrical current remains constant.
Slope	The slope of a linear calibration function.
Zero point	The zero point of a pH combination electrode is the pH value at which the electromotive force of the pH combination electrode at a specified temperature is zero. Normally, this is at 25 °C.

General information

Adjusting	To manipulate a measuring system so that the relevant value (e. g. the displayed value) differs as little as possible from the correct value or a value that is regarded as correct, or that the difference remains within the tolerance.
AutoRange	Name of the automatic selection of the measuring range.
Calibration	Comparing the value from a measuring system (e. g. the displayed value) to the correct value or a value that is regarded as correct. Often, this expression is also used when the measuring system is adjusted at the same time (see adjusting).
Measured parameter	The measured parameter is the physical dimension determined by measuring, e. g. pH, conductivity or D.O. concentration.

Measured value	The measured value is the special value of a measured parameter to be determined. It is given as a combination of the numerical value and unit (e. g. 3 m; 0.5 s; 5.2 A; 373.15 K).
Molality	Molality is the quantity (in Mol) of a dissolved substance in 1000 g solvent.
Reset	Restoring the original condition of all settings of a measuring system.
Resolution	Smallest difference between two measured values that can be displayed by a meter.
Stability control (AutoRead)	Function to control the measured value stability.
Standard solution	The standard solution is a solution where the measured value is known. It is used to calibrate a measuring system.
Temperature function	Name of a mathematical function expressing the temperature behavior of a test sample, a sensor or part of a sensor.
Test sample	Designation of the test sample ready to be measured. Normally, a test sample is made by processing the original sample. The test sample and original sample are identical if the test sample was not processed.

16 Index

A

Automatic switch-off	16
AutoRead	
ORP	35
pH	22

B

Battery compartment	11, 57
---------------------------	--------

C

Calibration	
pH	25, 37
Calibration evaluation	
pH	32
Calibration interval	42
Calibration points	
pH	31
Connecting a PC	53
Copyright	2

D

Dataset	51
Date and time	20
Default settings	
Measured parameter	44
System settings	45

E

Energy saving mode	48
--------------------------	----

F

Firmware update	65
-----------------------	----

I

Initial commissioning	10
Initialize	44
Interval for calibration	42

K

Keys	13
------------	----

M

Measured value display	16
Measurement accuracy	42
Measurement data storage	
Edit	49
Erase	49
Measurement dataset	51

Measuring

ORP voltage	35
pH	22
Menus (navigation)	17
Messages	18

P

pH buffer sets	39
Print	52
Printer (only pH 7310P)	54

R

Reset	44
-------------	----

S

Sample display	14
Scope of delivery	10
Single-point calibration	
pH	26, 29
Slope	
pH	25
Socket field	15
Storage interval	47
Storing in memory	46
Automatic	47
Manual	46

T

Temperature measurement	
pH	24, 37
Three-point calibration	
pH	27, 30
Transmitting data	52
automatic	52
manual	52
Transmitting measured values	52
Two-point calibration	
pH	26, 29

Z

Zero point of pH combination electrode ..	25
---	----

What can Xylem do for you?

We're a global team unified in a common purpose: creating innovative solutions to meet our world's water needs. Developing new technologies that will improve the way water is used, conserved, and re-used in the future is central to our work. We move, treat, analyze, and return water to the environment, and we help people use water efficiently, in their homes, buildings, factories and farms. In more than 150 countries, we have strong, long-standing relationships with customers who know us for our powerful combination of leading product brands and applications expertise, backed by a legacy of innovation.

For more information on how Xylem can help you, go to xyleminc.com.



Service address:

Xylem Analytics Germany
Sales GmbH & Co. KG
WTW
Dr.-Karl-Slevogt-Str. 1
82362 Weilheim
Germany

Tel.: +49 881 183-325
Fax: +49 881 183-414
E-Mail wtw.rma@xyleminc.com
Internet: www.WTW.com



Xylem Analytics Germany GmbH
Dr.-Karl-Slevogt-Str. 1
82362 Weilheim
Germany